

### Zócalos

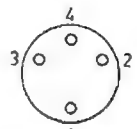

**Eu B4**

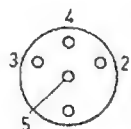

**Eu B5**

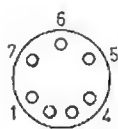

**Eu C**



**A UX4**

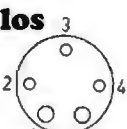

**A UX5**

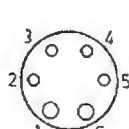

**A UX6**

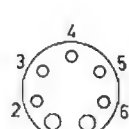

**A UX7**



**10-19 G8A**

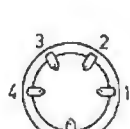

**0-9 P5**

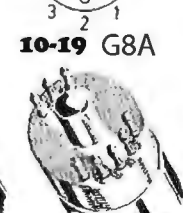

### Bases

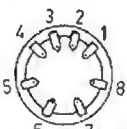

**0-9 P**

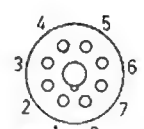

**30-39 I.O.**

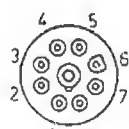

**20-29 B8G**

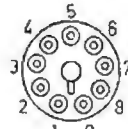

**60-69 B9G**

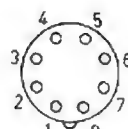

**40-49 B8A**

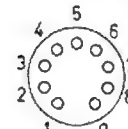

**80-89 B9A**

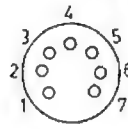

**90-99 B7G**

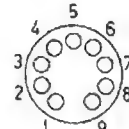

**50-59 B9D**

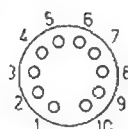

**Decal**

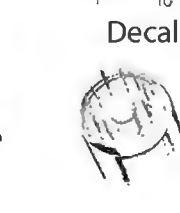
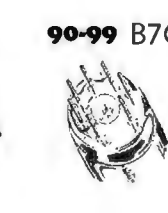
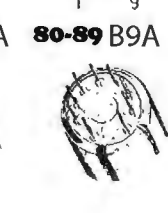
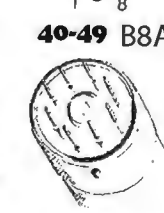

### Nuvistor



Type	Volt	Amp.	Fig.	Type	Volt	Amp.	Fig.
6811	6	0,5	6	8060	14	0,15	2
7121	6	0,05	3	8063	6	0,07	4
7170	6	0,3	1	8064	18	0,2	7
7176	4	0,04	3	8066	9	0,2	7
7199	6	0,025	4	8067	12	0,06	3
8017	2	0,21		8069	35	0,05	6
8019	4,5	0,3	2	8072	12	0,1	3
8023	6	0,18	5	8073	6	0,1	3
8033	5	0,2	2	8075	12	0,1	3
8034	10	0,2	2	8076	12	0,1	3
8037	6,3	0,1	2	8077	6	0,1	3
8038	5	0,2	2	8078	6	0,1	3
8040	6	0,5	6	8079	9	0,29	1
8041	4	0,1	2	8080	10	0,2	1
8042	4	0,5	2	8088	6,3	0,32	2
8043	6,3	0,09	2	8089	12	0,1	5
8045	6,3	0,32	2	8091	6,3	0,64	1
8046	6	0,5	6	8092	10	0,2	2
8047	4	0,11	6	8095	19	0,09	2
8049	6	0,6	6				
8053	6	0,4	6				
8054	6	0,23	6				
8056	4	0,2	3				
8057	2	0,09	2				
8058	4	0,1	2				
8059	6	0,1	2				

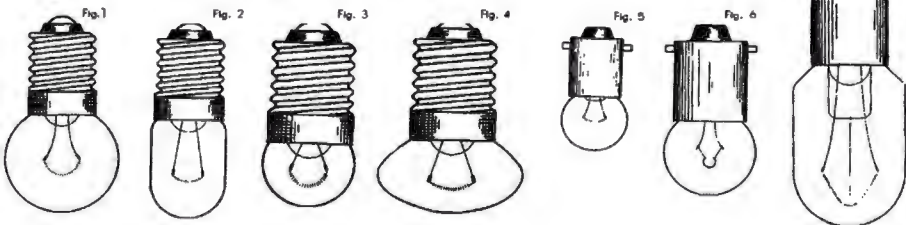

1939 (Ver Nostalgia Air Reference)

Fig	Volts	W	Amps	Bead	Lamp	Candl	Base	Bulb
1	2	0.12	0.06	Pink	48	-	E10	T-3½
1	2.1	0.252	0.12	White	-	-	E10	T-3½
1	2.5	1.25	0.5	White	41	0.5	E10	T-3½
1	3.2	1.6	0.5	Green	42	0.75	E10	T-3½
1	6.3	0.756	0.12	Brown	40	0.5	E10	T-3½
1	6.3	1.575	0.25	Blue	46	0.8	E10	T-3½
2	2	0.12	0.06	Pink	49	-	Bayo	T-3½
2	2.1	0.252	0.12	-	49-A	-	Bayo	T-3½
2	2.5	1.25	0.5	White	43	0.5	Bayo	T-3½
2	3.2	1.6	0.5	Green	45	0.75	Bayo	T-3½
2	6.3	0.945	0.15	Brown	40-A	0.5	Bayo	T-3½
2	6.3	0.945	0.15	Brown	47	0.5	Bayo	T-3½
2	6.3	1.575	0.25	Blue	44	0.8	Bayo	T-3½
3	6.5	2.6	0.4	White	-	1.5	E10	G-4½
3	6.5	2.6	0.4	White	55	1.5	E10	G-4½
4	7.5	1.5	0.2	White	50	1	E10	G-3½
5	7.5	1.5	0.2	White	51	1	Bayo	G-3½

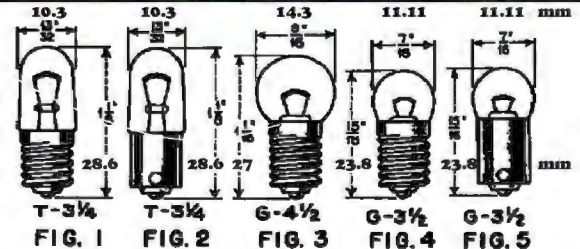

Señal	Sin señal	Débil	Fuerte	Emisora Local
6 E 5				
AM 2, C/EM 2 EFM 1 EFM 11, UFM 11				
EM 1, AM 1				
EM 4, UM 4 EM 34, UM 34				
EM 5 EM 11, UM 11 EM 35, UM 35 EM 171				
EM 71				
EM 80, UM 80				
EM 83				
EM 84 PM 84				
EM 85, UM 85				
	unausgesteuert	ausgesteuert	unausgesteuert	ausgesteuert
	EM 72		DM 70 DM 71	

## Übersicht der Abstimm-Anzeigeröhren

[DK4UL-05/1997]

Nr	Röhre	Sockel	Heizung	UB=	-UG/Triode	Anzeige	Hinweis
1	AM 1	Au 49	4,0V/0,30Ai	250 V	0/- 5 V	MA 4B-SW 90/16°	= 4697
2	AM 2	Au 50	4,0V/0,32Ai	250 V	+3/- 6 V	MA 2B 160/5°	= 4677
3	C/EM 2	Au 50	6,3V/0,2Ai	250 V	+3/- 6 V	MA 2B 160/5°	- - - -
4	DM 21	Oc 26	1,4V/25mAd	120 V	0/- 4 V	Mag.Auge 60/5°	- - - -
5	DM 70	SM 6	1,4V/25mAd	90 V	0/-10 V	Leuchtstr.0-14mm	Lötldr.1M3
6	DM 71	SN 6	1,4V/25mAd	150 V	0/-34 V	Leuchtstr.0-14mm	=1N3/Y25
7	DM160	SN 82	1,0V/30mAd	50 V	0/- 3 V	Mag. Band 0-10mm	= 6977
8	RAN 86	No 88	6,3V/0,3Ai	200 V	0/- 7 V	Mag.Waage -3/12mm	= 6GX8
9	EPM 1	Au 52	6,3V/0,2Ai	250 V	-2/-20 V	Mag.A.2B-SW 70/5°	- - - -
10	EPM 11	St 28	6,3V/0,2Ai	250 V	-1,5/-20 V	Mag.A.2B-LW 70/3°	- - - -
11	EM 1	Au 49	6,3V/0,2Ai	250 V	0/- 5 V	Mag.A.4B-LW 90/6°	= 4678
12	EM 3	Au 50	6,3V/0,2Ai	250 V	0/-21 V	Mag.A.4B-LW 90/9°	- - - -
13	EM 4	Au 51	6,3V/0,2Ai	250 V	0/-4/-16V	MA 2B-SW 90/ 5/0°	= EM 34
14	EM 5	Au 51	6,3V/0,2Ai	250 V	s. EM 11	(82: 90/55/5°	= EM 11
15	EM 11	St 29	6,3V/0,2Ai	250 V	0/-4/-20V	MA 4B-SW 75/15/7°	= EM 35
16	EM 34	Oc 47	6,3V/0,2Ai	250 V	= EM 4	MA 2B-SW = EM 4	6AF7/6CD7
17	EM 35	Oc 47	6,3V/0,2Ai	250 V	= EM 11	MA 4B-SW = EM 11	= 6U5G
18	EM 71	Lo 21	6,3V/0,3Ai	250 V	0/-20 V	MF 1B-SW 120/0°	- - - -
19	EM 71a	Lo 21	6,3V/0,3Ai	250 V	= EM 71	=EM 71 mit engen Toleranzen	- - - -
20	EM 72	Lo 21	6,3V/0,3Ai	250 V	= EM 71	ausgesp.Sektoren 70-20°	= 6U5
21	EM 80	No 54	6,3V/0,3Ai	250 V	0/-20 V	MF 1B-LW 50/5°	= 6BR5
22	EM 81	No 54	6,3V/0,3Ai	250 V	0/-20 V	MF 1B-SW 65/5°	= 6DAS
23	EM 81	No 67	6,3V/0,3Ai	250 V	0/-8/-16	MW 2B-LW 3-23 mm	ex DDR
24	EM 84	No 75	6,3V/0,21i	250 V	0/-22 V	MB 1B-LW 21-0 mm	= 6FG6
25	EM 84a	No 75	6,3V/0,27i	250 V	0/-10 V	MB 1B-LW 21-0 mm	- - - -
26	EM 85	No 75	6,3V/0,3Ai	250 V	0/-18 V	MF 1B-SW 100/0°	= 6DU6
27	EM 87	No 75	6,3V/0,3Ai	250 V	0/-10 V	MB 1B-LW 21-0 mm	= 6HU6
28	EM 800	No 75	6,3V/0,3Ai	240 V	0/-10 V	MB 1B-LW 3-30 mm	Thermomet
29	EM 840	No 75	= EM 84	250 V	= EM 84	MB enge Toleranzen	- - - -
30	ENM 801	No 72	6,3V/0,3Ai	250 V	0/-20 V	MW 2x 27/0mm Länge	- - - -
31	ENM 803	No267	6,3V/0,45i	250 V	0/-15/-1-4	StMB 22-0/0/5mm L.	-> St.Anz.
32	HM 34	Oc 47	8,5V/0,15i	200 V	= UM 4	- - - - - - - -	- - - -
33	HM 71	Lo 21	12,6V/0,15i	250 V	= EM 71	- - - - - - - -	= 12U5
34	HM 85	No 75	12,6V/0,15i	250 V	= EM 85	- - - - - - - -	- - - -
35	PM 84	No 75	4,2V/0,3Ai	200 V	= UM 84	- - - - - - - -	= 9FG6
36	UFM 11	St 28	15,0V/0,1Ai	200 V	-0,5/-18 V	MA 2B-LW 81/9°	- - - -
37	UM 4	Oc 27	12,6V/0,1Ai	200 V	0/-4/-12,5	MA 2B-SW wie EM 4	= 10M2
38	UM 11	St 29	15,0V/0,1Ai	200 V	0/-3/-20 V	MA 4B-SW wie EM11	= 13MU4
39	UM 34	Oc 47	12,6V/0,1Ai	200 V	= UM 4	MA 2B-SW wie EM 4	- - - -
40	UM 35	Oc 27	15,0V/0,1Ai	200 V	= UM 11	MA 4B-SW wie EM11	- - - -
41	UM 80	No 54	19,0V/0,1Ai	170 V	0/-13 V	MF 1B-LW wie EM80	= 19BR5
42	UM 81	No 54	19,0V/0,1Ai	170 V	= UM 80	MF 1B-SW wie EM81	Dunkelst.
43	UM 84	No 75	12,5V/0,1Ai	200 V	0/-15 V	MB 1B-LW 20-0 mm	= 12FG6
44	UM 85	No 75	19,0V/0,1Ai	200 V	0/-13 V	MF 1B-SW 90/0°	- - - -

MA = Magisches Auge  
MF = Magischer Fächer

MB = Magisches Band  
MW = Magische Waage

LW = Leuchtwinkel  
SW = Schattenwinkel

Vergleichstypen (= identisch bis auf Sockel oder Heizung = Anzeige ähnlich)  
[Sockelschaltungen siehe Franzis-RTT, 14.Auflage 1994]

AM 2 = C/EM 2 = AM 1 = EM 1 = EPM 1 = E/UFM 11 - - -> MA 2B 1 Anzeige  
EM 4 = EM 34 = UM 4 = UM 34 = HM 34 - - - - -> MA 2B 2 Anzeigen  
EM 11 = EM 35 = EM 5 = UM 11 = UM 35 - - - - -> MA 4B 2 Anzeigen  
EM 71 = EM 72 = HM 71 - - - - -> MF 1B 1 Anzeige  
EM 80 = EM 81 = EM 85 = HM 85 = UM 80 = UM 81 = UM 85 -> MF 1B 1 Anzeige  
EM 84 = EM 840 = EM 84a = EM 87 = PM 84 = UM 84 - - - -> MB 1B 1 Anzeige



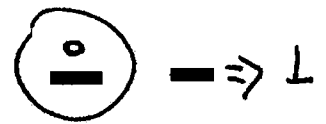
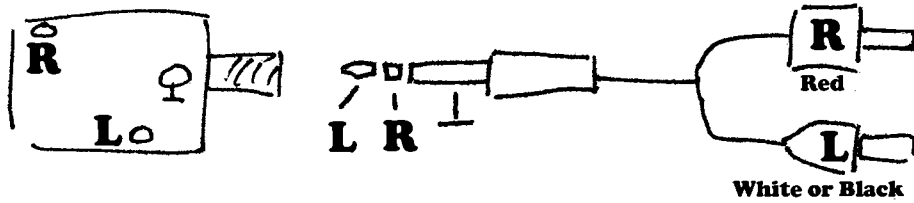

**P/B Secuencia**

**Mono: 1-4-3-2**

**Estereo: 1/3-4/2**

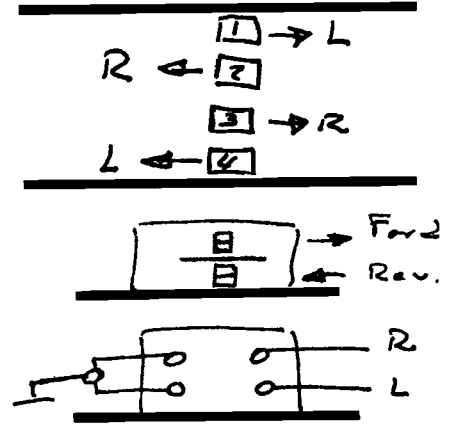
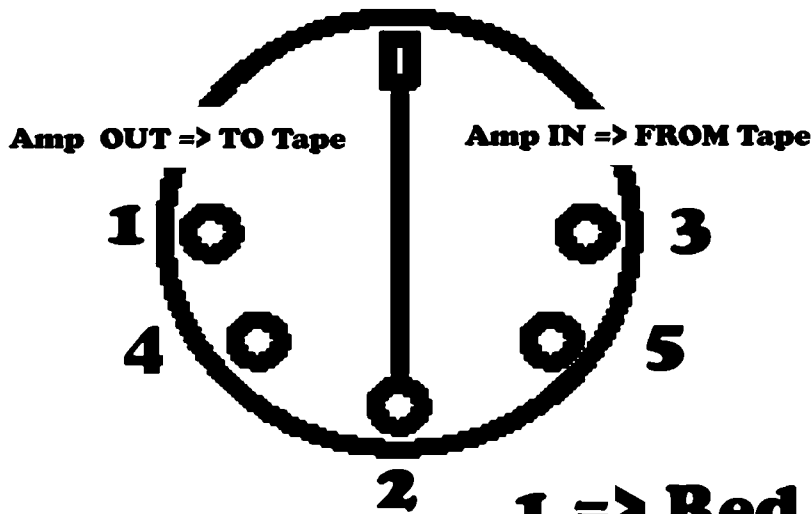

**1,3,2 => Mono**

**1.3 => Left**

**4,5 => Right**

**1 => Red**

**4 => White**

**5 => Black**

**3 => Yellow**

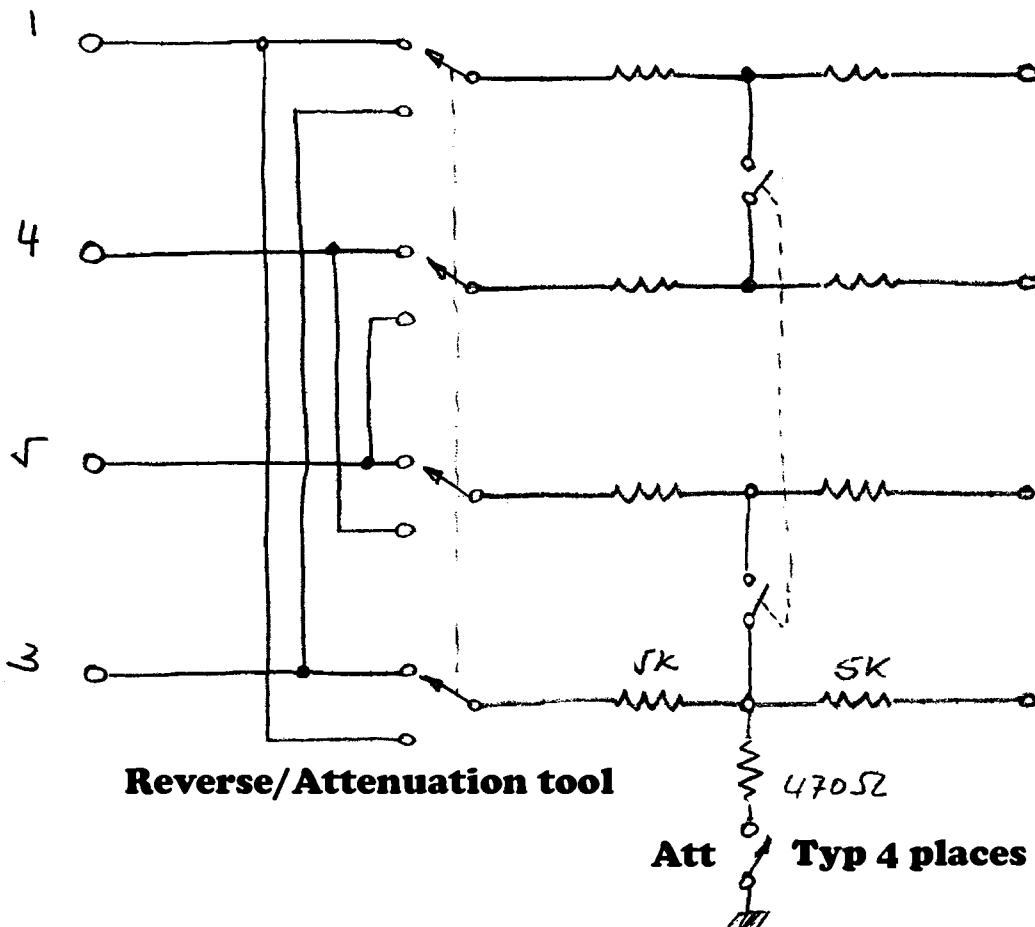

Cada día es mayor el número de aficionados a AUDIO y VIDEO, que se cuestionan sobre la posibilidad de interconexión entre periféricos tales como videos, cadenas HI-FI cámaras y televisores. Es pensando en solucionar este problema, para lo que se ha desarrollado el EUROCONECTOR o SCART, el cual es incluido hoy día como standar en todos los equipos de video que se fabrican en Europa, algunos japoneses y algunos equipos de audio. De cualquier modo, los equipos que no disponen de EUROCONECTOR, vienen con salidas entradas de audio y video tipo CINCH, las cuales son compatibles con este conector a través de los correspondientes cables, fabricados al efecto.

SEÑALES AUDIO-VIDEO

Para comprender las ventajas que puede reportar el uso de Euroconector, hemos de entender antes las posibles formas en que se presentan las señales de audio y video en los sistemas de transmisión de TV. Europeos. En nuestro caso haremos la descripción del sistema PAL, con sonido Steréo SSQ.

La información de video ( imagen ), viene como una señal portadora modulada en amplitud, acompañada de los impulsos de sincronismo correspondientes para poder no sólo hacer visible sobre la pantalla dicha imagen, sino que además, ha de verse en "sincronía" con la de la emisora. Tras eliminar la portadora que la acompaña, obtenemos la envolvente, que se denomina CVBS ( composity video blanking and sincro ), señal que es posible grabar en los videos domésticos, para posteriormente poderla reproducir en pantalla cuantas veces se dese.

En lo referente al sonido, actualmente se utiliza un sistema de transmisión steréo muy similar al empleado en radiodifusión comercial de FM, el cual nos permitirá además de la transmisión de señales estereofónicas, transmisiones de doble lenguaje.

Llegado éste momento, se entiende que necesitamos tres conductores aislados para transportar por un cable una señal completa de video. Uno para video y dos para audio. Es también comprensible que, caso de señales monofónicas, podemos prescindir de uno de los canales de audio, en cuyo caso sólo necesitamos dos conductores.

El zócalo hembra del Euroconector.

(Visto desde el lado del cableado).

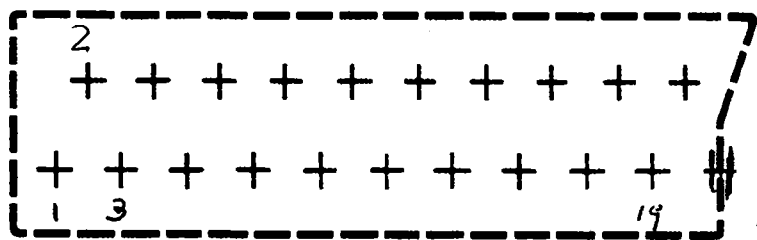

Macho pines

Ubicación de la placa protectora

#21

Este conector, ha sido desarrollado para la conexión de los televisores domésticos, al cada vez más creciente número de periféricos que están apareciendo en el mercado para el consumidor.

Su composición es la indicada en la fig-1 y 2, y la función de cada uno de sus pines es la siguiente:

- 1- salida de audio canal derecho nivel = 500 mV/1K
- 2- entrada audio canal derecho nivel = 500 mV/10K
- 3- salida de audio canal izquierdo nivel = 500mV/1K
- 4- masa de audio general
- 5- masa para color AZUL (B)
- 6- entrada de audio canal izquierdo nivel = 500 mV/10K
- 7- entrada de azul ( B) nivel = 700 mV/70
- 8- entrada de control
- 9- masa para color verde ( G)
- 10- linea intercomunicación
- 11- entrada de verde (G) nivel = 700 mV/70
- 12- linea intercomunicación
- 13- masa para color rojo (R)
- 14- masa linea intercomunicación
- 15- entrada de rojo (R) nivel = 700 mV/70
- 16- señal de estado RGB
- 17- masa para CVBS
- 18- masa para R-G-B
- 19- salida de CVBS nivel = 1V/75
- 20- entrada CVBS nivel = 1V/75
- 21- malla zócalo y pantalla cables

} VIDEO

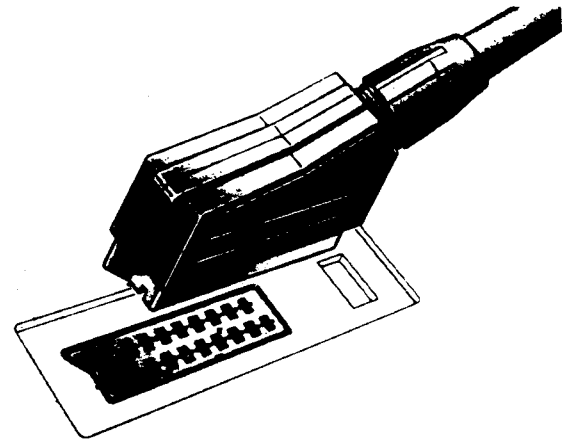

El enchufe macho del Euroconector.

(Visto desde el lado del cableado)

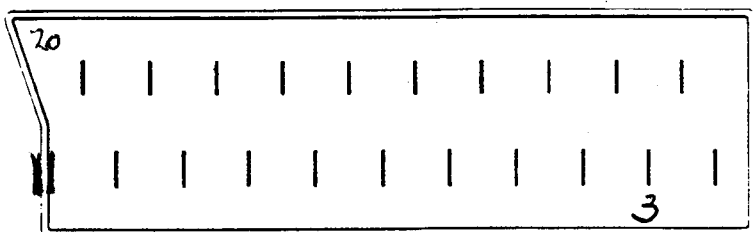

Hembra pines

Placa protectora

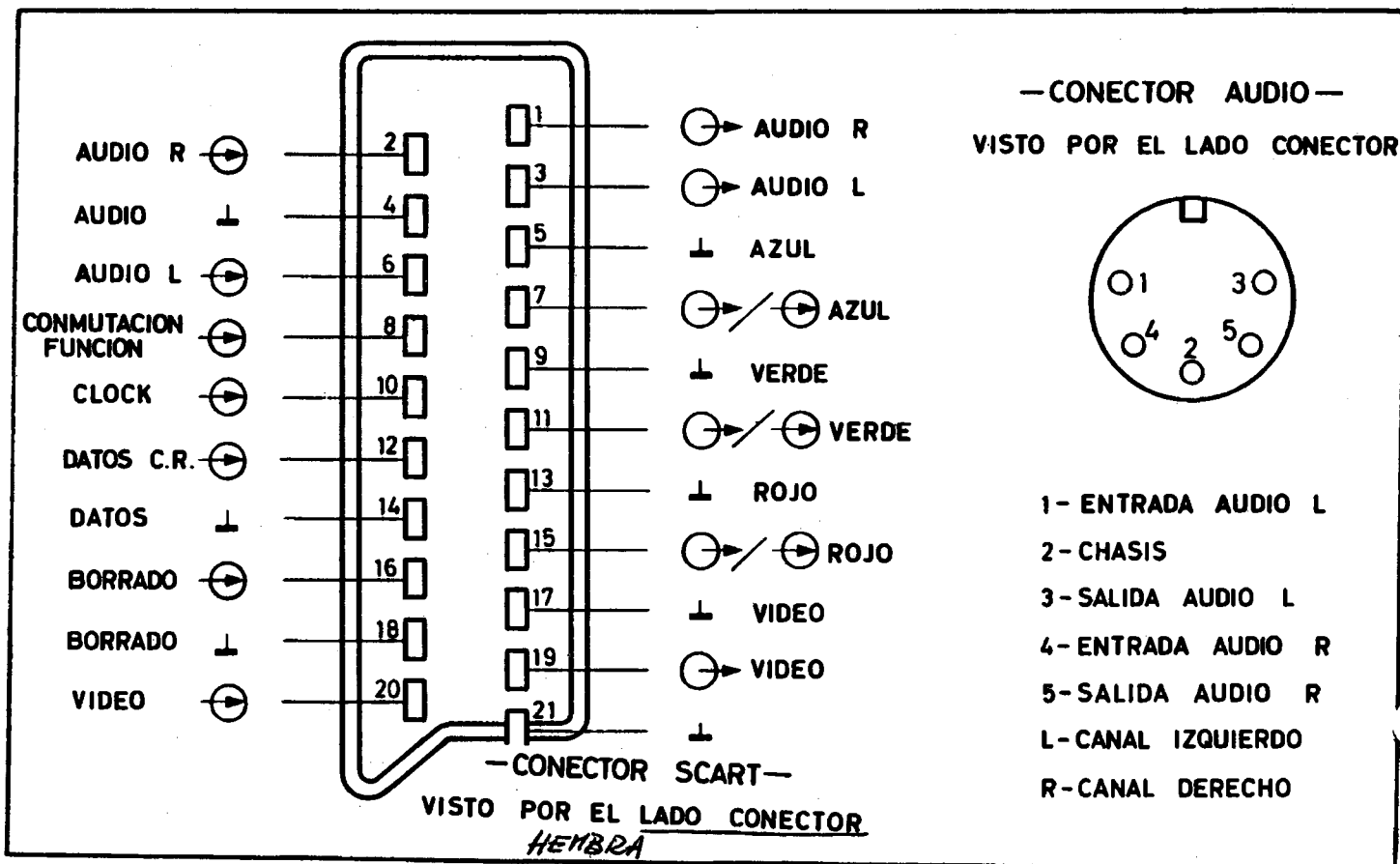

**DESCRIPCION DE PINES**

El EUROCONECTOR completo, utiliza los 21 pines que lo constituyen, pero es obvio que, dependiendo de los periféricos a conectar, necesitaremos solamente algunos de ellos. Por tanto, existirán cables específicamente contruidos para unir distintos equipos de audio-video. En efecto, no tiene sentido llevar información de video a un amplificador de potencia de audio, y nunca obtendremos de éste ninguna información. Por otra parte un Compact-disk, por ejemplo, solo genera audio, etc.,. En las figuras 3 a 9 se indican las conexiones má habituales.

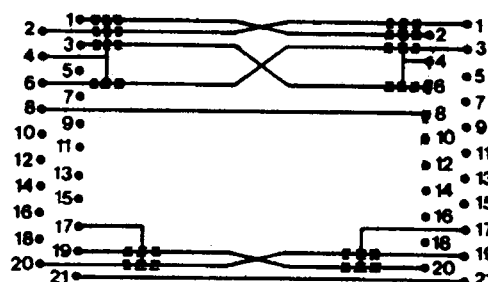
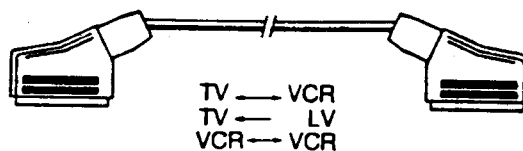

**FIG.4. Euroconector con señales de Audio (stéreo y video (entrada salida).**

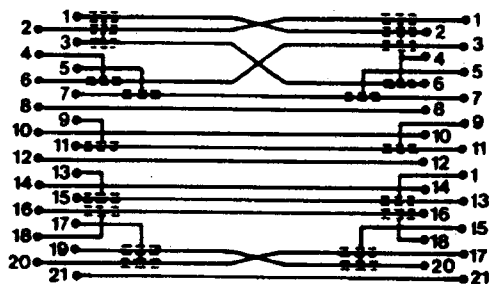
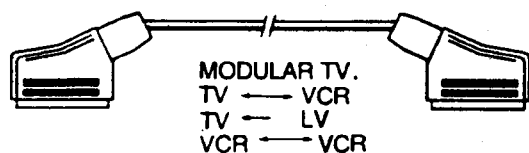

**FIG.3. Euroconector completo para unir 2 periféricos que tengan ambos, dicha conexión.**

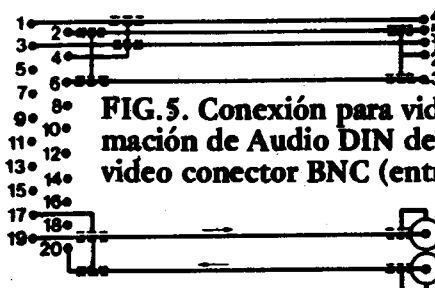
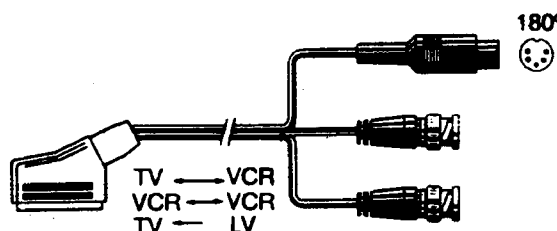

**FIG.5. Conexión para videocámaras que lleven información de Audio DIN de 180° (entrada y salida) y video conector BNC (entrada salida).**

Entrehierro para Au Single Ended = 0.1 a 0.5 mm

### Dimensiones laminado "E" "I"

(B en mm) (I en mm)	CENTRAL B 2*I	"I" B/2 I	LARGO 3*B 6*I	CORTO 2.5*B 5*I	VENTANA 1.5*B 3*I
<b>EI-12.5</b>	<b>12.5</b>	<b>6.25</b>	<b>37.50</b>	<b>31.25</b>	<b>18.75</b>
<b>EI-12.5</b>	<b>12.5</b>	<b>6.75</b>	<b>38.50</b>	<b>32.00</b>	<b>19.50</b>
EI-14	14.0	7.0	42.0	35.0	21.0
EI-14	14.0	8.0	44.0	36.0	22.0
<b>EI-16</b>	<b>16.0</b>	<b>8.0</b>	<b>48.0</b>	<b>40.0</b>	<b>24.0</b>
EI-18	18.0	9.0	54.0	45.0	27.0
EI-18	18.0	10.0	56.0	47.0	28.0
EI-20	20.0	10.0	60.0	50.0	30.0
EI-22	22.0	11.0	66.0	55.0	33.0
EI-25	25.0	12.5	75.0	62.5	37.5
<b>EI-28</b>	<b>28.0</b>	<b>14.0</b>	<b>84.0</b>	<b>70.0</b>	<b>42.0</b>
EI-32	32.0	16.0	96.0	80.0	48.0
EI-36	36.0	18.0	108.0	90.0	54.0
EI-42	42.0	21.0	126.0	105.0	63.0
EI-50	50.0	25.0	150.0	125.0	75.0
EI-65	65.0	32.5	195.0	162.5	97.5

Las medidas con este fondo, no siguen las reglas matematicas. Valores obtenidos de una tabla

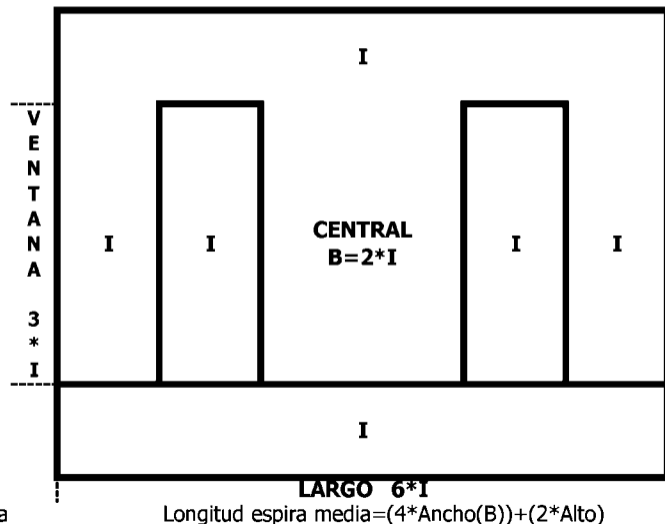



FUGA EN  $\Gamma$  en 300VDC (o menos)

22/5/95

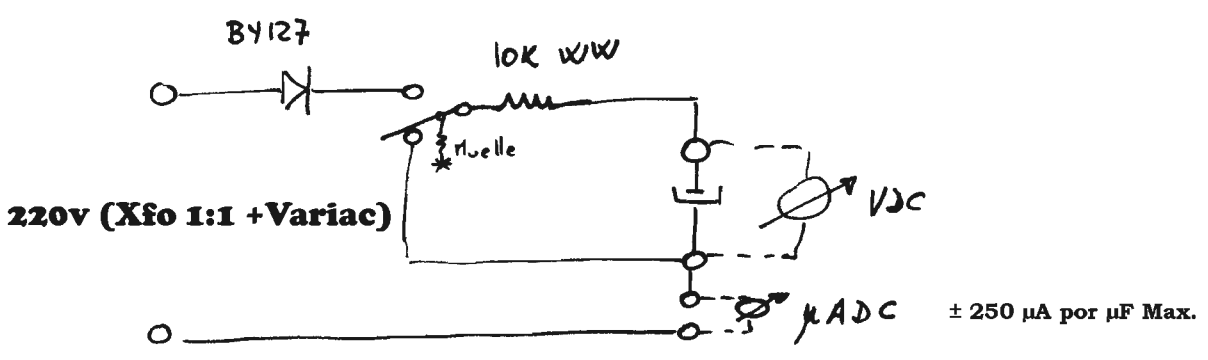

$$i_{max} = \frac{311V}{10K} \approx 31 \mu A \quad P_{max} = 9.7W \therefore WW$$

$$T \approx 5 \times R \times C \approx \underline{\underline{10 \text{ seg}}} \quad (\text{Para } C = 200 \mu F)$$

MUY IMPORTANTE :

- 1) Verificar ANTES, de que tensión es el electrolítico y poner el VARIAC a  $\frac{E}{\sqrt{2}}$  aprox.
- 2) Permitir que el condensador se descargue ANTES de retirarlo de las pinzas de conexión. y tensión muy próxima a la nominal
- 3) TODOS los  $\mu$  que probé, bajaron a 0,5  $\mu A$  al cabo del tiempo (algunos  $\pm 15'$ ) por lo que hay que darle tiempo para que se 'formen'  $\pm 250 \mu A$  por  $\mu F$  Max.

**Para C Ele de baja tension**

$\phi - 20VDC$   
 P<sub>limit</sub> 100 mA

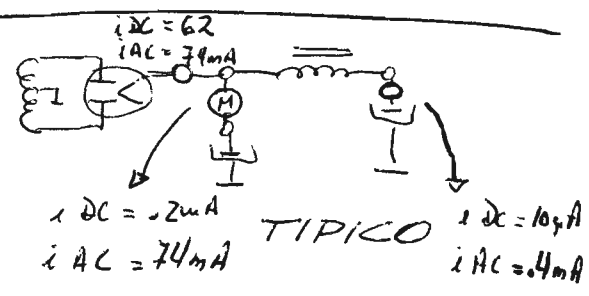
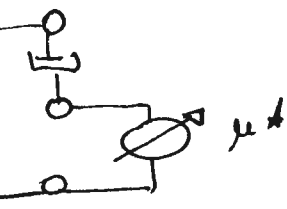

RF Gen @ Máx. Sin Modular (aprox 22mV pp) Osciloscopio en 5mV x 1  
VOBULADOR Conm @ Med Atte. @ 3/4 hor. Osciloscopio = (8cuadros)

Rp	Tipo de Conversora
0.3	6A7 6A8
0.7	6SA7 6K8
1.0	6BE6 ECH81 ECH42 ECH11
1.3	ECH3 ECH35 ECH41 ECH83 AK2

**Ajuste FUERA de la radio :**  
**Ajustar a 2KHz MENOS de la FI deseada**

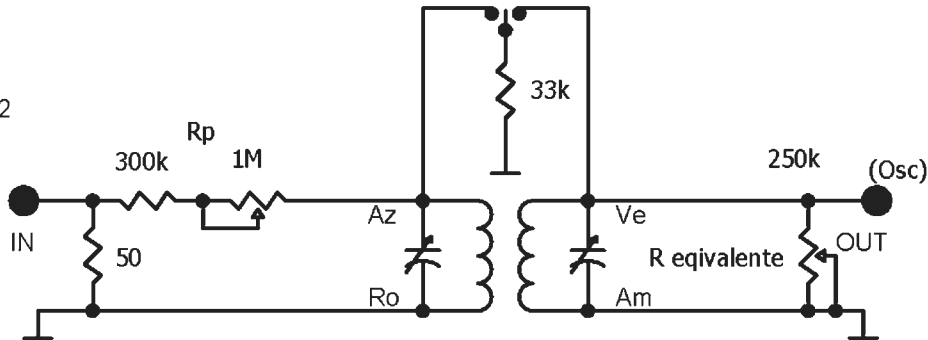

# Audio Load

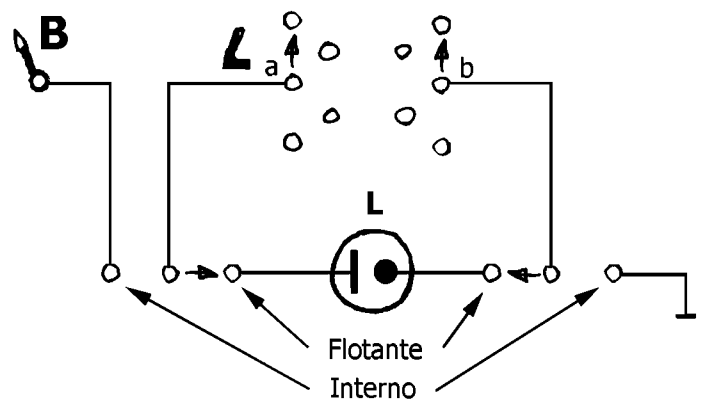
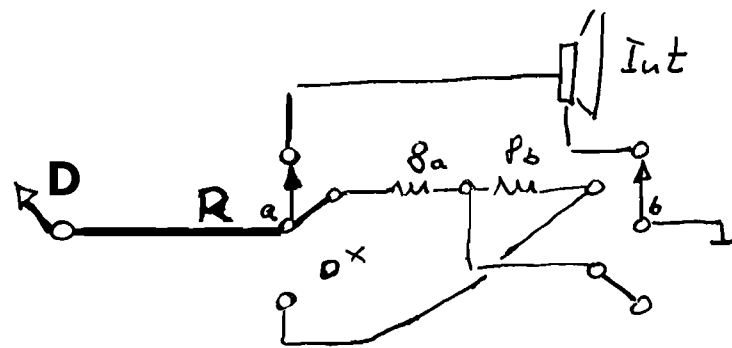
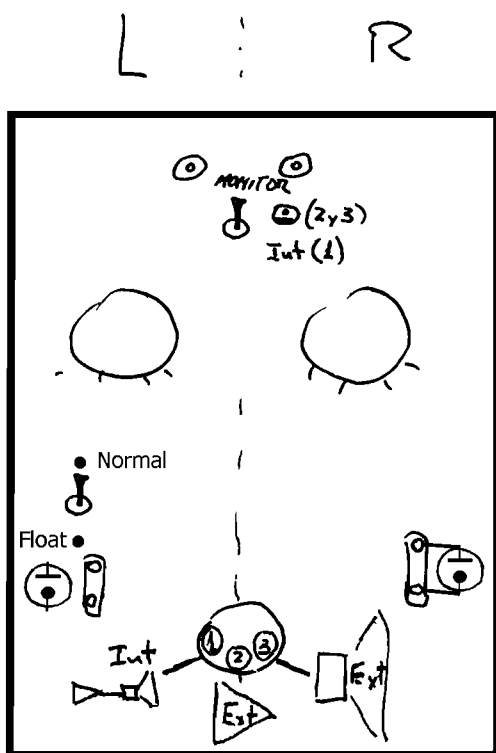
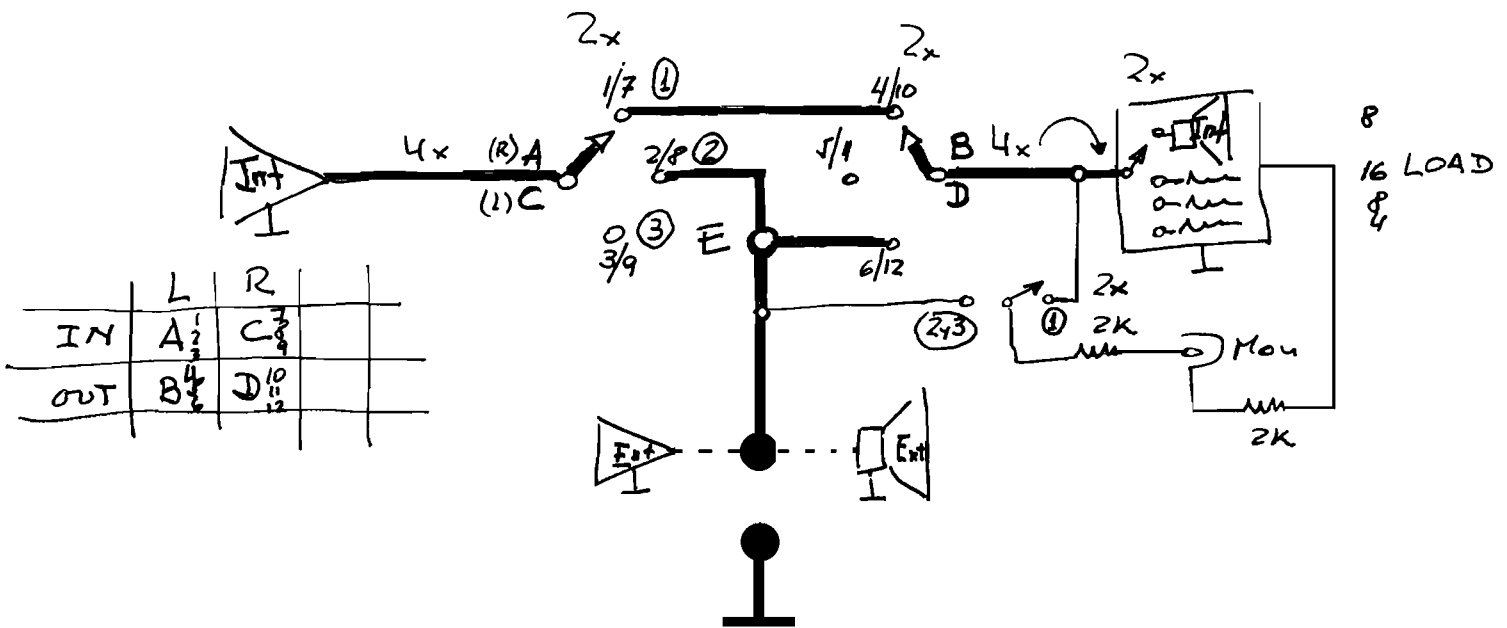
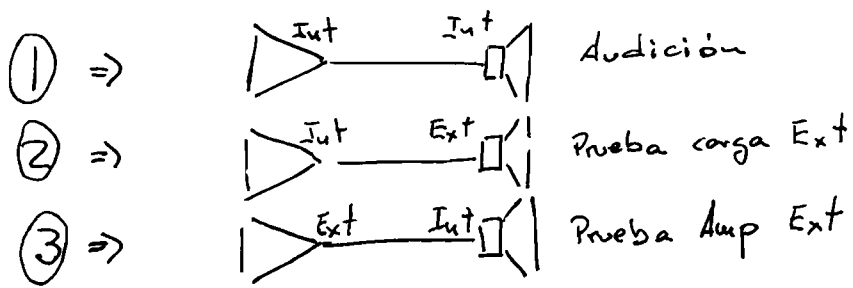

Sólo desde Din L

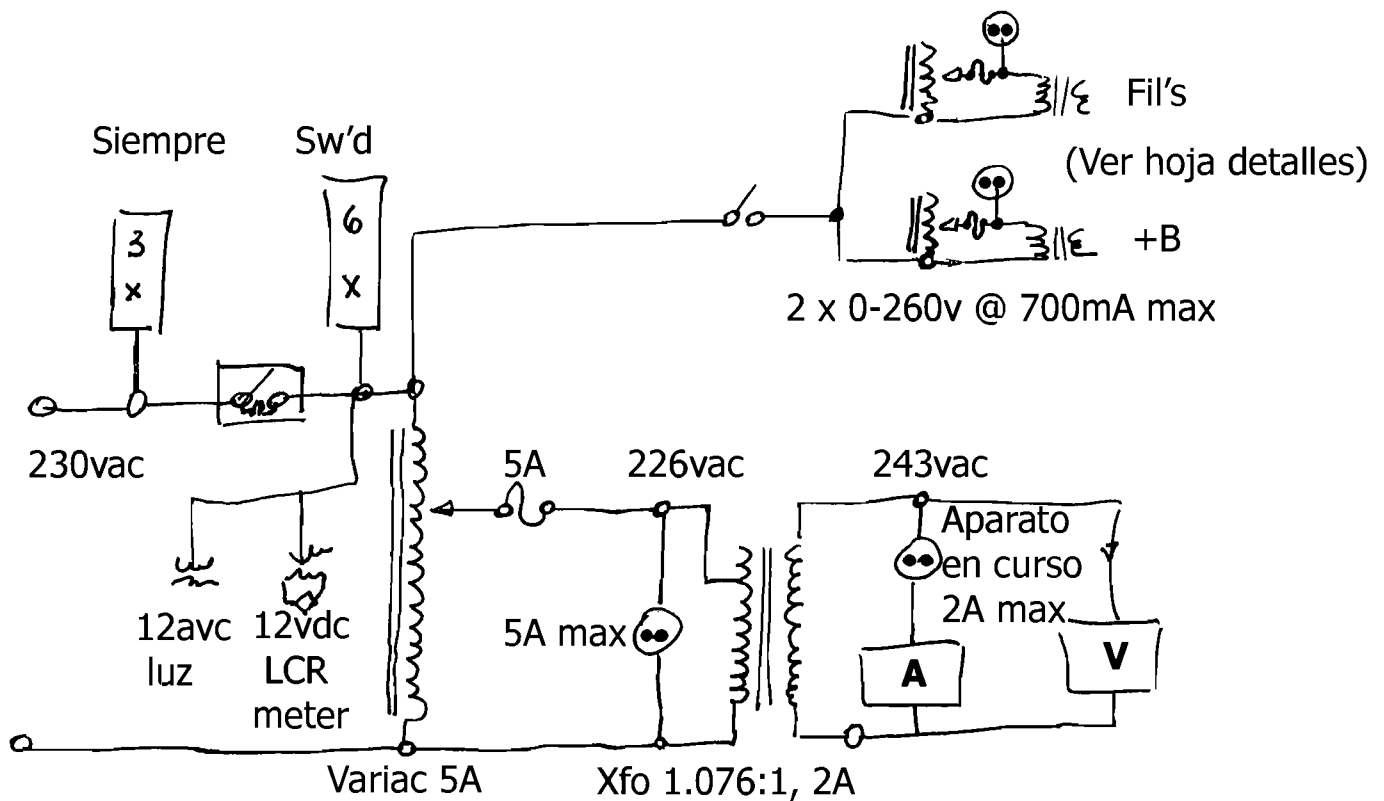
**Siempre:**

UPS para el PC + pantalla + router

Cargadores de; destornillador, soldador a baterías, pilas, móvil, etc

**Sw'd:**

Resto periferia del PC, herramientas, instrumentos, luces etc

Aparato en curso de restauración/repación.

Variacs de la FA exterior. (Ver hoja de detalles).

+ B

En Secundario: No usar DC y AC simultáneamente

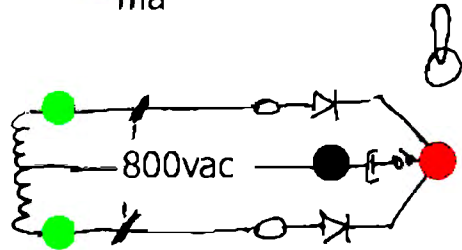
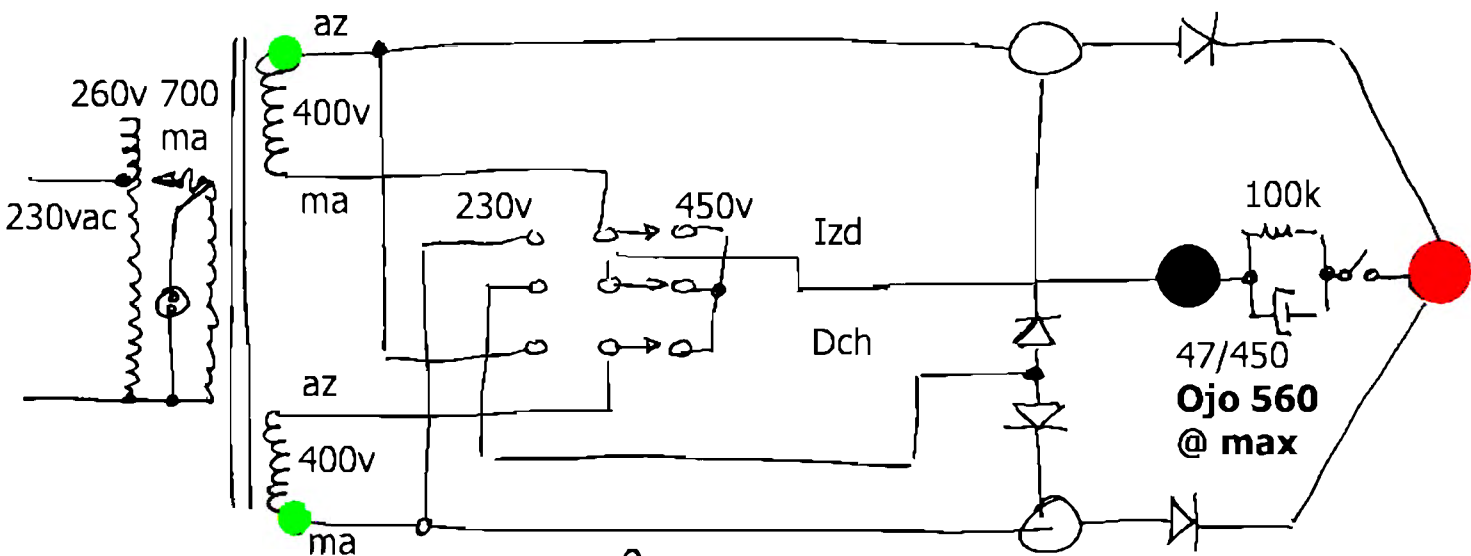

DC=450v@150ma; AC=175ma

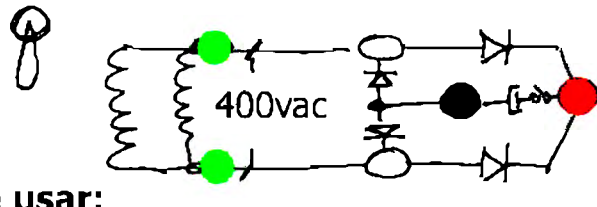

DC=450v@210ma; AC=350ma

Se puede usar:

### Fil's

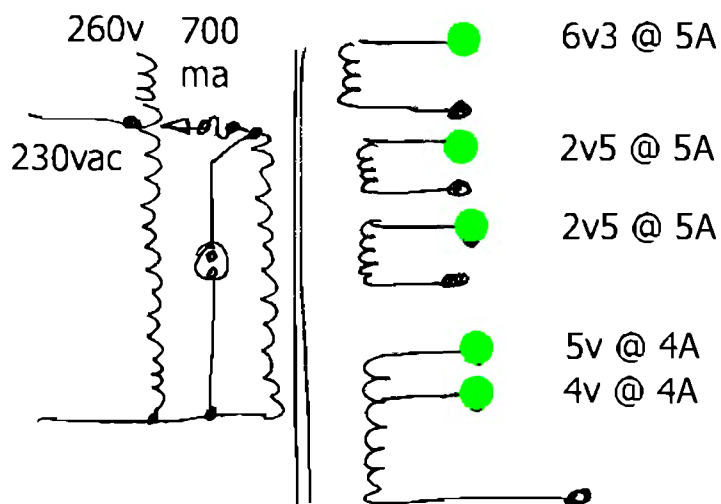

16v3  
Total  
todos  
en  
serie



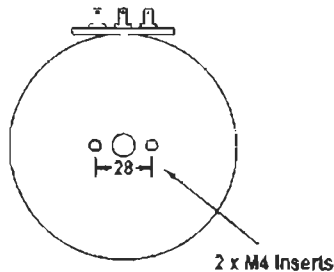
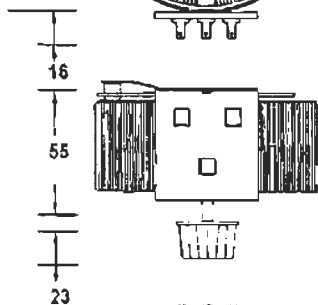
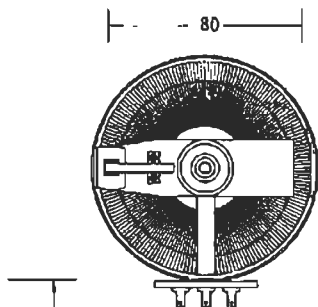

Fixing Detail

PART NO CMV0.7F-1R

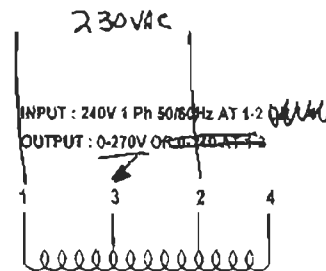

CONNECTION ARRANGEMENT

## OPEN STYLE VARIABLE TRANSFORMERS INSTALLATION AND SAFETY INSTRUCTIONS

1. Read all of these instructions before you use the transformer.
2. This transformer is not designed to provide mains isolation.
3. Variable transformers operate at mains voltage.  
**DO NOT EXCEED THE MAXIMUM VOLTAGE AND CURRENT RATING.**
4. Installation connection and maintenance should only be carried out by suitably qualified personnel.
5. This transformer is open style and must be fitted within its own enclosure or within a protected environment.
6. When connected to the electrical supply the terminals, brushes and track face are at mains potential with a potentially lethal voltage.
7. The input must always be applied across the load.  
Never connect the transformer in series with the load.
8. The carbon brush should be inspected for damage or wear, faulty or worn brushes will result in damage to the windings.

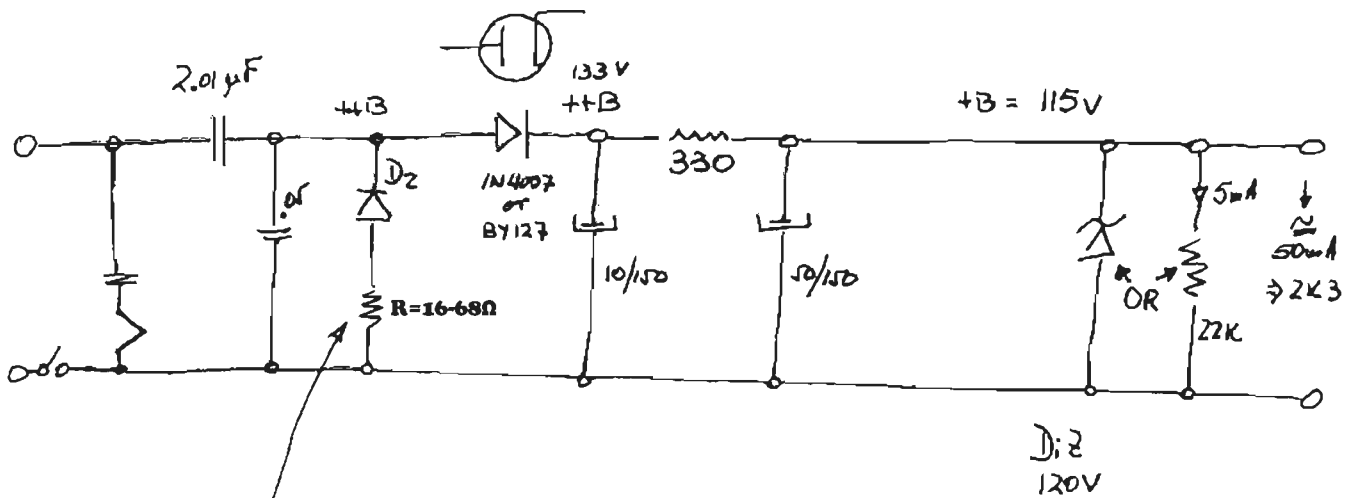
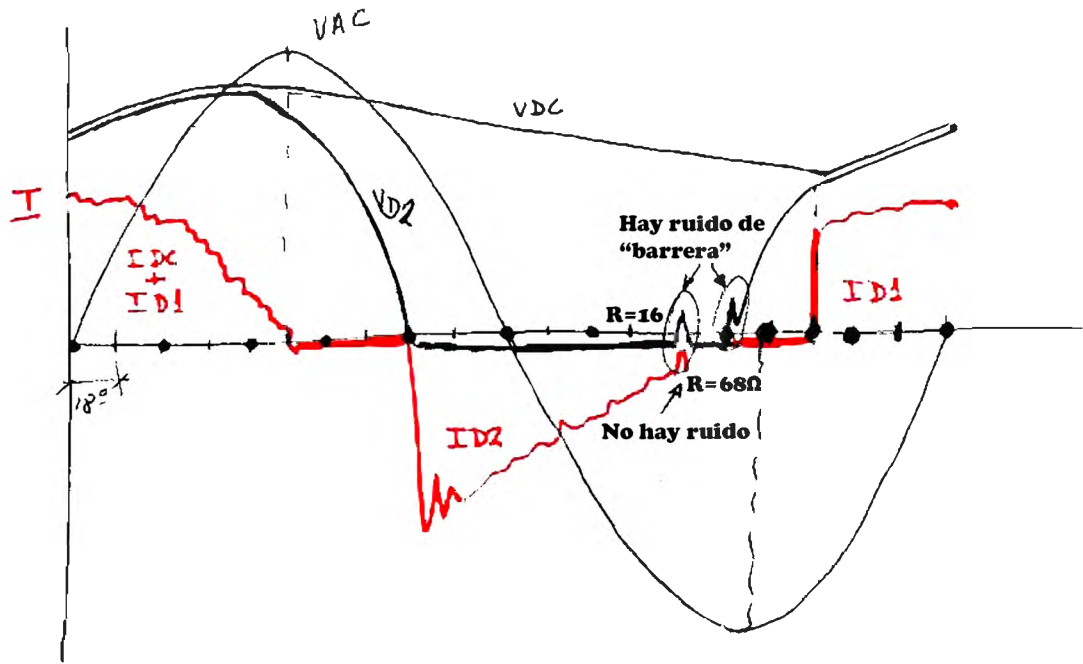

PROBAR :

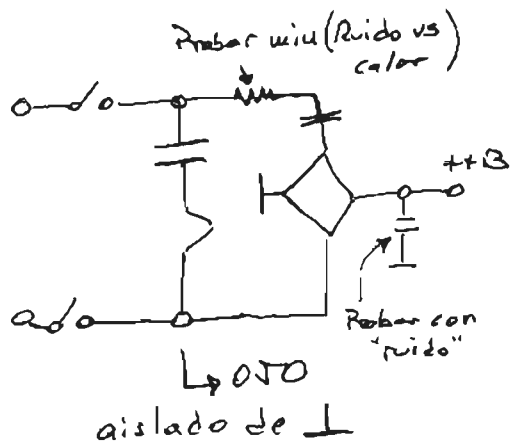



# PHILIPS-SERVICE

## DOCUMENTATIE KAARTEN

### Radiobuizen gebruikt in ontvangtoestellen van 1932-1945

Buis type	Schema nr.	Buis type	Schema nr.	Buis type	Schema nr.	Buis type	Schema nr.
AB1	27	C243N	24	E446	29	EL11	70
AB2	67	C443	24	E447	29	EM1	56
ABC1	35	C453	24	E452T	28	EM3	39
ABL1	45	CB1	68	E455	28	EM4	58
AC2	33	CB2	67	E462	28	EM11	72
AF2	29	CBC1	35	E463	6	EZ1	62
AF3	42	CBL1	45	E499	23	EZ2	62
AF7	42	CBL6	45	EAB1	31	EZ3	62
AK1	8	C/EM2	57	EB1	80	FZ1	62
AK2	53	CF1	42	EB4	30	KB2	67
AL1	38	CF2	42	EBC3	35	KBC1	34
AL2	41	CF3	42	EBC11	69	KC1	32
AL4	40	CF7	42	EBF1	46	KC3	32
AL5	40	CK1	53	EBF2	46	KCH1	52
AM1	56	CL1	41	EBL1	45	KDD1	36
AZ1	61	CL2	41	EBL21	77	KF2	7
AZ2	61	CL4	41	ECF1	44	KF3	37
AZ11	73	CL6	41	ECH3	54	KF4	37
B217	1	CY1	60	ECH4	55	KH1	47
B228	1	CY2	63	ECH11	71	KK2	51
B240	79	DAC21	9	ECH21	16	KL4	38
B252	2	DAC25	74	EF1	42	KL5	38
B255	2	DCH25	15	EF2	42	UBL1	13
B262	2	DF21	11	EF5	42	UBL21	77
B438	1	DF22	11	EF6	42	UCH4	17
B443	24	DF25	75	EF8	48	UCH21	16
B543	24	DK21	14	EF9	42	UF9	12
B2038	23	DL21	10	EF11	70	UM4	20
B2043	6	DL25	76	EF22	78	UY1	21
B2044	5	DLL21	18	EFM1	59	UY1N	21
B2046	29	DM21	19	EH2	50	UY21	22
B2052T	28	E409	23	EK1	53	506	4
C1	64	E424	23	EK2	53	1561	4
C2	64	E424N	23	EK3	53	1801	4
C8	65	E428	23	EL1	41	1805	4
C9	64	E438	23	EL2	41	1821	4
C10	66	E443	24	EL3	40	1823	4
C13	49	E444	5	EL6	40	1883	43

### Verklaring van de teekens der buisaansluitingen

<i>a</i>	= anode	<i>g2</i>	= tweede rooster
<i>a1</i>	= eerste anode	<i>g3</i>	= derde rooster
<i>a2</i>	= tweede anode	<i>g4</i>	= vierde rooster
<i>aH</i>	= hexode of heptode anode	<i>g5</i>	= vijfde rooster
<i>aT</i>	= triode anode	<i>g6</i>	= zesde rooster
<i>aP</i>	= penthode anode	<i>gT</i>	= triode rooster
<i>d</i>	= diode anode	<i>gH</i>	= hexode of heptode rooster
<i>d1</i>	= eerste diode	<i>k</i>	= kathode
<i>d2</i>	= tweede diode	<i>k1</i>	= eerste kathode
<i>D</i>	= deflectieplaat	<i>k2</i>	= tweede kathode
<i>f</i>	= gloeidraad	<i>k3</i>	= derde kathode
<i>f1</i>	= gloeidraadeind met diode d1	<i>l</i>	= fluorescentiescherm
<i>f2</i>	= gloeidraadeind met diode d2	<i>m</i>	= metallisering
<i>fc</i>	= middenaftakking van de gloeidraad	<i>r</i>	= weerstandsdraad
<i>g</i>	= rooster	<i>s</i> of <i>sc</i>	= afscherming in de buis
<i>g1</i>	= eerste rooster		

# Philips-Service

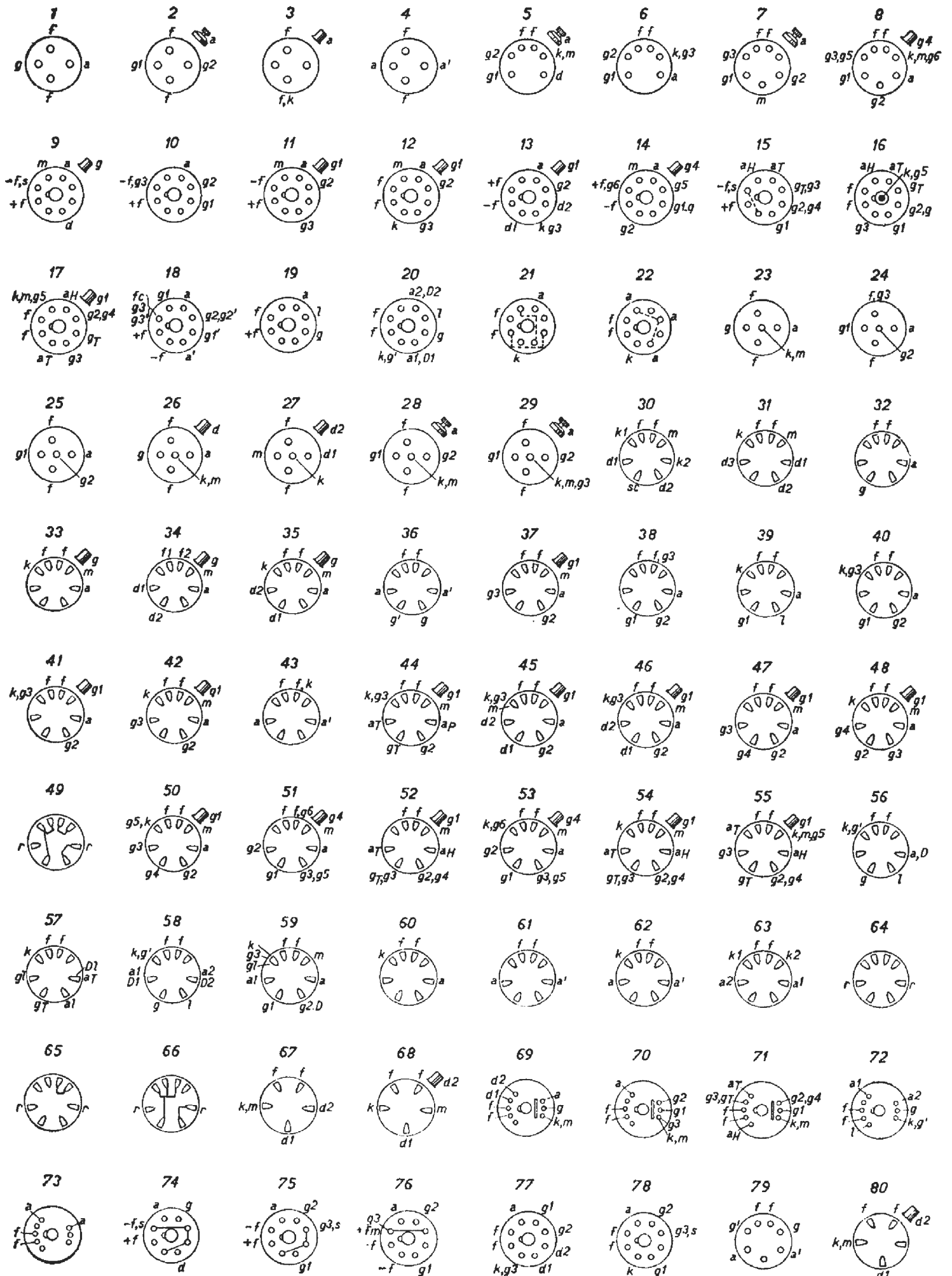

TERMAN (265)

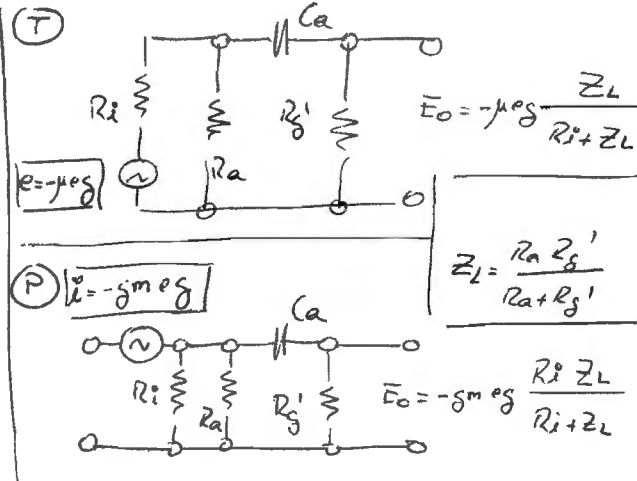
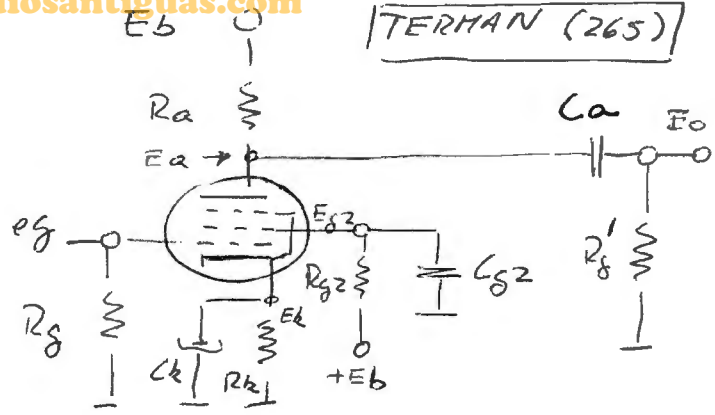

1º Elegir valvula

2º Fijar  $R_{g'}$

3º  $R_{a(p)} = 0.2 R_{g'} \rightarrow R_{g'}$  ( $E_o > p_{max}$ ) (A)  $R_{a(t)} = (3 \rightarrow 6) \times R_i$

4º  $p_{max} \geq 0K?$  Si  $\Rightarrow ok$  No  $\Rightarrow < R_a$

5º  $C_a = \frac{1}{2\pi f_{min} R}$   $R(p) = R_{g'} + \frac{R_i \times R_a}{R_i + R_a}$   
 para  $f_{min} = 70.7\%$  o  $-3dB$  de  $f_0$   
 $R(t) =$

6º  $I_a$  (tol que)  $E_a = I_a \times R_a = 0.45 \times E_b$  si  $R_a = R_{g'}$  0.2  
 $= 0.55 \times E_b$  "  $R_a = 0.2 R_{g'}$  \*  
0.4

Si no se necesita  $E_o > 5V = 0.9 \times E_b \Rightarrow A' = A + 20\% A$

Si  $E_o > \pm 5V \Rightarrow E_b = E_o(pico) \times (2.5 \rightarrow 4)$

\*  $\Rightarrow E_o = (0.2 \rightarrow 0.4)$  de  $E_b$  (sin excesiva distorsión)

- 7º Elegir  $E_{g2}$   $E_k$  para  $I_a$   
 "  $R_{g2}$  para  $E_{g2}$   
 "  $R_k$  para  $E_k$
- $C_{g2}$  y  $C_k$  para  $f_{min}$ .

$I_a$  (tol que)  $E_a = I_a R_a (0.5 \rightarrow 0.333) E_b$

Triodo =  $<$  tot para  $E_o$  grande  
 $<$  A que pentodo  
 $<$   $p_{max}$  " " para  $A_T = A_p$



ETE (14) (110)

TRÍODO

$$V_c = V_g + \frac{V_a}{\mu}$$

Para  $V_g = -\frac{V_a}{\mu} \Rightarrow I_a = \emptyset$

$\therefore \frac{V_a}{\mu}$  se llama Tensión de desplazamiento

---

PENTODO

ETE (14) (139)

$$V_c = V_g + \frac{V_{g2}}{\mu_{g2}} + \frac{V_a}{\mu_{g2} \times \mu_a}$$

$\frac{V_a}{\mu_{g2} \times \mu_a}$  Tensión de desplazamiento

---

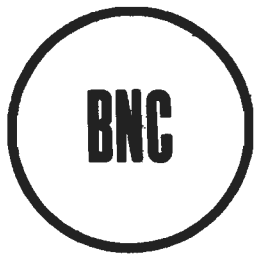

Mil-Crimp & Quick-Crimp

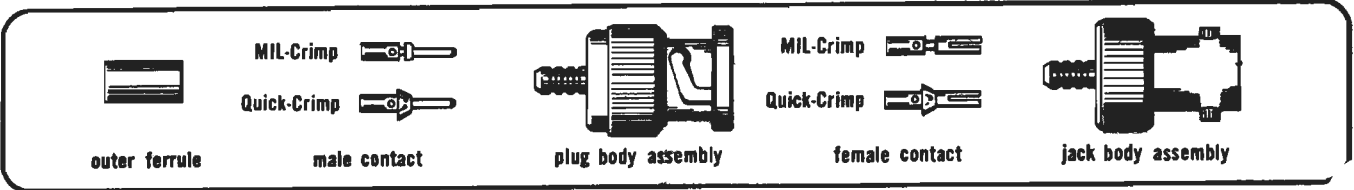

Strip cable jacket, braid, and dielectric to dimensions shown in table. All cuts are to be sharp and square. Important: Do not nick braid, dielectric, and center conductor. Tinning of center conductor is not necessary if contact is to be crimped. For solder method, tin center conductor avoiding excessive heat. Slide outer ferrule onto cable as shown.

stripping dims. ( $\pm \frac{1}{64}$ )	MIL-Crimps			Quick-Crimps		
	a	b	c	a	b	c
plugs & jacks	1/4	1 3/4	1/8	1/4	3/32	1 1/4
right angle plugs	1/4	1 3/4	1/8	1/4	3/16	1 1/4
bulkhead jacks	1/4	1 3/4	1/8	1/4	1/4	1 1/4

Flare slightly end of cable braid as shown to facilitate insertion onto inner ferrule. Important: Do not comb out braid.

Place contact on cable center conductor so that it butts against cable dielectric. Center conductor should be visible through inspection hole in contact. Crimp or solder the contact in place as follows:

crimp method

Crimp center contact using either of the following two tools: **Tool No. 227-912-1000** — To crimp the male contact (pin), insert the end of the nest bushing marked "P" into the tool. To crimp the female contact (socket), insert the end of the nest bushing marked "S" into the tool. **Tool No. 227-917 (MS-3191-A)** — To crimp the male contact (pin), insert the positioner marked 227-918 into the tool. To crimp the female contact (socket), insert the positioner marked 227-919 into the tool.

solder method

Soft solder contact to cable center conductor. Do not get any solder on outside surfaces of contact. Avoid excessive heat to prevent swelling of dielectric.

Install cable assembly into body assembly so that inner ferrule portion slides under braid. Push cable assembly forward until contact snaps into place in insulator. Slide outer ferrule over braid and up against connector body. Crimp outer ferrule with tool specified in table.

Amphenol crimp tools

RG-/U cable	tool no.
55,B; 58,A,B,C; 122; 141,A; 142,A,B; 161; 174; 180,A,B; 187; 188; 195,A; 223; 21-597; 421-637	227-50 or 227-150
59,A,B; 62,A,B,C; 71,A,B; 140	227-75 or 227-175

■ For RG-161, 174, 187, 188/U cables only, slit jacket back .100  $\pm$  .015 as shown. Before attaching center contact, slide metal spacer and Teflon sleeve (not shown) over cable dielectric. The center contact should butt against the dielectric and Teflon sleeve.

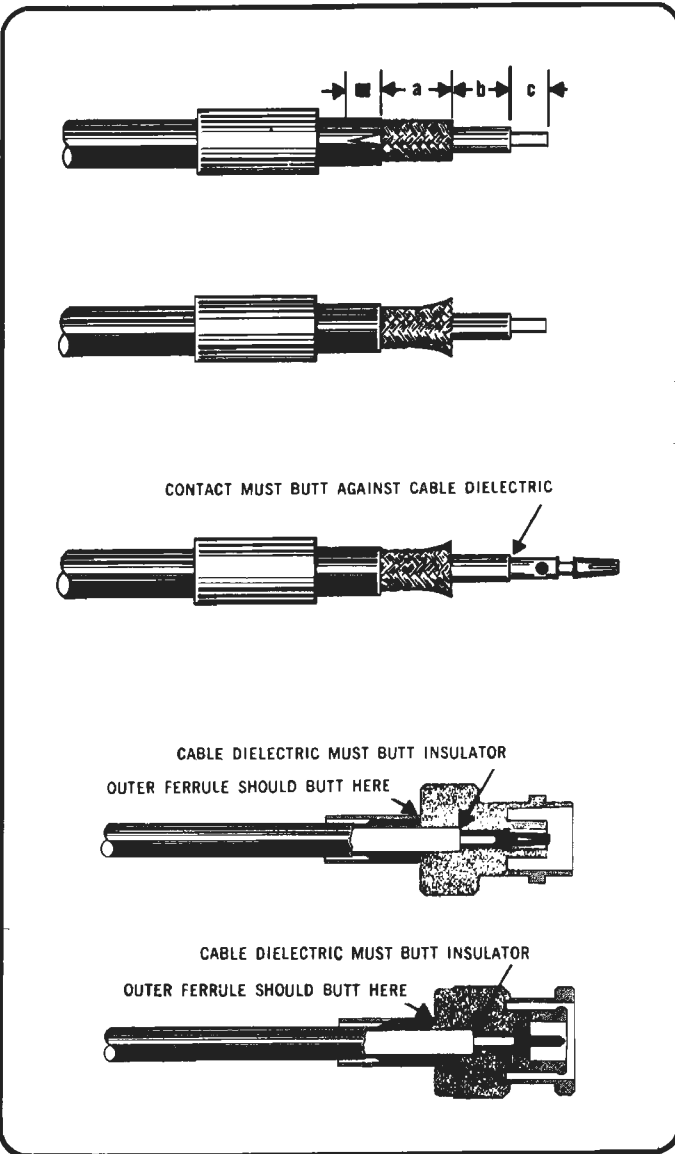

# 8. 7" PROFESSIONAL HEX/OVAL TYPE RATCHET CRIMPING TOOL FOR F, BNC, TNC, N, FIBER-OPTIC THINNET-PVC & THINNET-TEFLON CONNECTORS.

## A SPECIFICATION OF ALL DIMENSION AND RG SIZE:

TOOL HT:					O PIN	SO PIN	FOR CRIMPING RG TYPE CABLE	GRIPS COLOR
301A		.250" 6.8	.213" 5.41		.068" 1.72		59, 62, 140, 210 BELDEN 8279, 55, 58, 141, 142, 223, 303, 400, Fiber Optic	YELLOW
301B	.319" 8.1		.213" 5.41	.187" 4.75			6, 65, 68, 141, 142, 223, 303, 400, Fiber Optic	BLUE
301C	.319" 8.1	.254" 6.6	.213" 5.41		.068" 1.72		6, 59, 62, 140, 210, BELDEN 8279, 55, 58, 141, 142, 223, 303, 400, Fiber Optic	RED
301D	.324" 8.3	.254" 6.5	.213" 5.41		.068" 1.72		58, 59, 62, 6, 140, 141, 142, 212, 222, 303, Fiber Optic BELDEN 8281, 8279, 9231, 9411	GREEN
301G	.255" 6.48	.313" 8.1	.137" 3.50	.100" 2.54	.068" 1.72	.043" 1.1	59, 62, 8X, 140, 210, BELDEN 8279, 55, 58, 141, 142, 174, 223, 303, 400, Fiber Optic	GREEN
301U	.178" 4.52	.151" 3.84	.128" 3.25	.078" 2.00	.068" 1.72	.042" 1.07	122, 174, 179, 180, 187, 188, 195, Fiber Optic 178, 318, BELDEN 8218	YELLOW
301K	.429" 10.9		.128" 3.25	.100" 2.5			8, 9, 11, 87A, 140, 185, 213, 214, 216, 225, 303, 174, 179, 187, 188, 318, BELDEN 9913	YELLOW
301P		.244" 6.20		.205" 5.20		.035" 0.92	58, 59, 62(Oval Type)	GREEN
230A		.255" 6.48	.213" 5.41	.187" 4.75	.068" 1.72		55, 58, 59, 62, 140, 141, 142, 210, 223, 174, 303, 400, Fiber Optic, BELDEN 8279	BLUE
2301		.311" 7.9	.248" 6.3	.204" 5.2	.09" 2.3	.083" 1.6	58, 59, 6 & 174	GREEN
230PA	.324" 8.22	.255" 6.48	.213" 5.4	.10" 2.5	.068" 1.72		55, 58, 59, 62, 5, 6, 21, 141, 142, 143, 210, 212, 222, 223, 303, 304, 400, BELDEN 8279, 8281, 9231 & 9411	GREEN
311A	.449" 11.4	.346" 8.8		.079" 2.0	.058" 1.48		70, 50, 40.	GREEN
		.276" 7.0		.071" 1.8	.063" 1.6			

## Amphenol RFX™ 31-320-RFX BNC CRIMP PLUS FOR RG-58, 141, 142

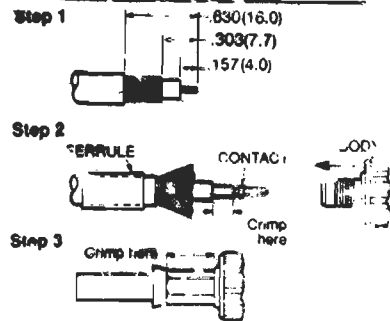

Cable	Center Conductor Hex Crimp Size	Outer Conductor Hex Crimp Size	Crimp Tool
RG-58, 141, 142A	006 (1.7mm)	.213 (5.4mm)	CTL-1

Amphenol RFX Products Made in Taiwan  
 Phones: U.S.A. 1-800-827-7166; Europe 00-1-800-827-7166  
 Asia 650-333-0787; other (international) 1-800-769-8888

## B USE WITH OTHER STRIPPING TOOL TO COMPLETE JOB

1. Series of coaxial cable stripper.

Tool No	Stripping RG-cable	Description
HT-302A	-59,62 & 6	A: 6, 8, 12 mm
HT-302B	-58,59 & 62	
HT-332	-58,59,62,6 & 3C2V	
HT-312A	-59,62 & 6	mm
HT-312B	-58,59 & 62	
HT-312S	O.D.from 7mm to 10.5mm	
HT-312X	O.D.from 3.5mm to 4.5mm	

- (1) 2Blades coaxial cable stripper.  
 HT-302A for RG-6,59(62)  
 HT-302B for RG-58,59(62)  
 HT-332 for RG-58,59(62),6

- (2) 3Blades coaxial cable stripp-  
 HT-312A for RG-6,59(62)  
 HT-312B for RG-58,59(62)

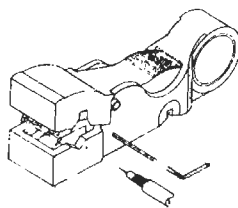
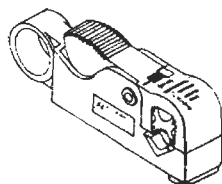

2. HT-108 Stripping AWG 10-30 and Fiber Optic wire.

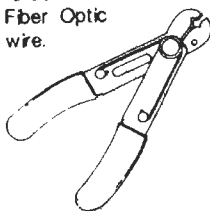

3. HT-1091 Cutter/Stripper FOR 24-26 AWG

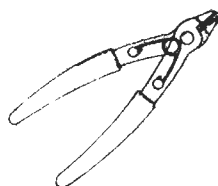

4. HT-206 cable

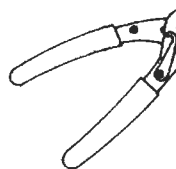

MADE IN TAI

VALVOMETRO3-3-01

Usando como patron el Tecktronix TRUE RMS,  
ajusto el meter del valvómetro a  $i = AC + DC$   
variando las  $R$

	TEMA	PONGO
3mA	263	159
10mA	23.2	19.8
30mA		
100mA		
300mA		

Le doy mas tensión al muelle del relé de protección  
para que no se salte con  $5mA$  la escala de  $10mA$   
Hay que poner una  $R$  // bobina del relé para que no  
se active al menos hasta  $15mA$ .

# BASS REFLEX

Mejor proporción = Ancho x Alto x Profundo = 3:4:2

$f = \alpha \frac{A^{1/4}}{V^{1/2}}$ <p style="text-align: center; margin-top: 5px;">59.387</p>	$V = \frac{\alpha^2}{f^2} A^{1/2}$	$A = \frac{f^4}{\alpha^4} V^2$
---	------------------------------------	--------------------------------

$\alpha = 2,070$  dimensiones en pulgadas

$\alpha = 5,257.8$  " " centímetros

$$A = \frac{\pi V^2}{4} \left( \frac{2\pi f}{c} \right)^4$$

MAX dimensión > 1/3 de  $\lambda$

$c = \text{vel sonido Aire } 20^\circ\text{C} = 13.524 \text{ m/seg} = 34.351 \text{ cm/seg}$

<b>MEDIDAS REALES</b>	$A = 40 \times 15$	$= 600 \text{ cm}^2$
	$A = 15.748 \times 5.906$	$= 93 \text{ " }^2$
	$V = 40 \times 59.5 \times 798$	$= 192.000 \text{ cm}^3$
	$V = 15.748 \times 23.622 \times 31.496$	$= 11.717 \text{ " }^3$

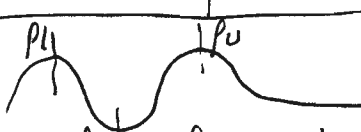

$P_r = \text{Peg de Resonancia aire Libre?}$

$P_L = P_{\text{min}}$      $P_U = P_{\text{max}}$   
TUNED

$P_r = \text{Media geométrica de } P_L \times P_U$

$$P_r = \sqrt{P_L \times P_U}$$