

PHOTOFACT® Folder

with CIRCUITRACE®

TELEFUNKEN MODELS
ALLEGRO 5183W, BOLERO 5182WK,
SONATA 5183WK, WEIN 5184WK

Au PLATO Telefunken TW504c
Au Cápsula Telefunken T200



MODEL WEIN 5184WK

TRADE NAME	Telefunken Models Allegro 5183 W, Bolero 5182WK, Sonata 5183WK, Wein 5184WK		
SUPPLIER	American Elite, Inc., 48-50 34th Street, Long Island City 1, N. Y.		
TYPE SET	AC Operated 8 Tube BC-SW-FM Receiver With 2 Tube FM Multiplex Adapter And 4Speed Automatic Record-Changer		
POWER SUPPLY	115/230 Volts AC, 60 Cycles	RATING	64 Watts, .61 Amp. @ 117 Volts AC (For BC-SW-FM Receiver) 8 Watts, .007 Amp. @ 117 Volts AC (FM Multiplex)
TUNING RANGE - BROADCAST	525-1630 KC	FREQ. MOD.	88-108 MC
	SHORTWAVE 2 6.9-22.5 MC	SHORTWAVE 1	2.25-6.95 MC

FOR SERVICE INFORMATION ON RECORD CHANGER - SEE TELEFUNKEN TW504S - PHOTOFACT SET 651 FOLDER 12

DIAL CORD STRINGING

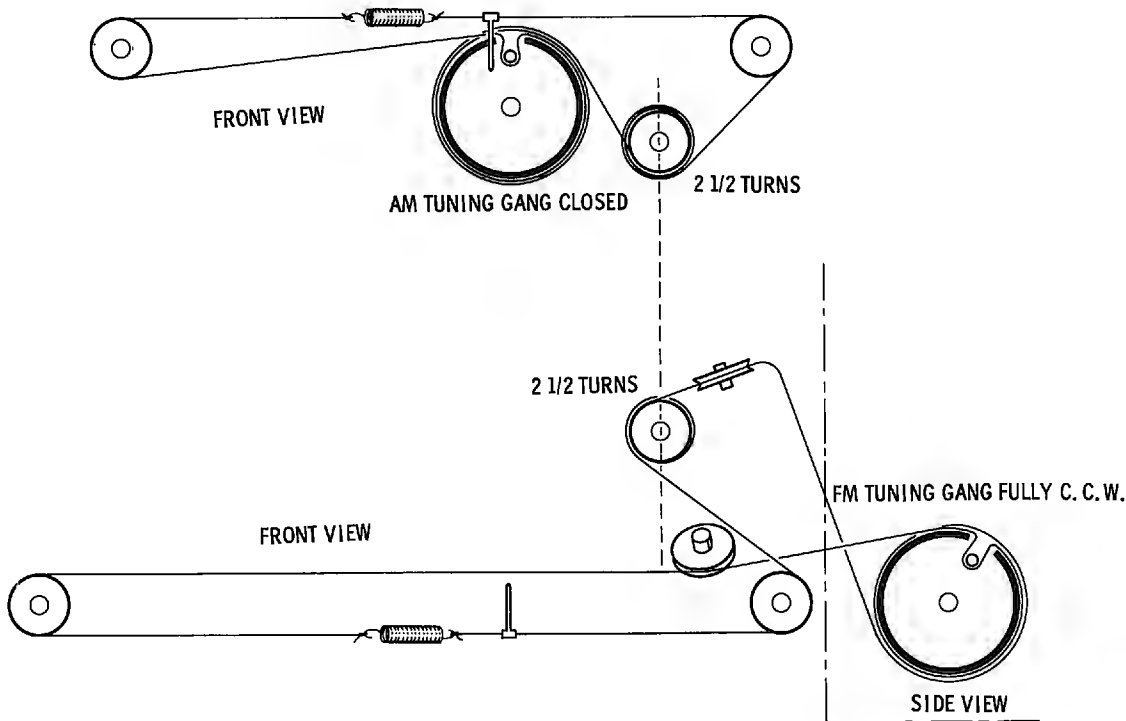

HOWARD W. SAMS & CO., INC. Indianapolis 6, Indiana

The listing of any available replacement part herein does not constitute in any case a recommendation, warranty or guaranty by Howard W. Sams & Co., Inc., as to the quality and suitability of such replacement part. The numbers of these parts have been compiled from information furnished to Howard W. Sams & Co., Inc., by the manufacturers of the particular type of replacement part listed.
LN949

Reproduction or use, without express permission, of editorial or pictorial content, in any manner, is prohibited. No patent liability is assumed with respect to the use of the information contained herein. © 1963 Howard W. Sams & Co., Inc., Indianapolis 6, Indiana. Printed in U. S. of America

DATE 11-63

SET 665 FOLDER 12



TELEFUNKEN MODELS ALLEGRO 5183W, BOLERO 5182WK, SONATA 5183WK, WEIN 5184WK

SET 665 FOLDER 12

Schaltbild mit Strom- und Spannungswerten

Die Einstellung der Trimmer A (C 106) - B (C 107) - C (C 113) soll nicht verändert werden, da sonst die Sintonisierbarkeit und Stabilität sowie die Eingangsleistung des Gerätes nicht mehr gewährleistet ist (siehe Abgleichtabelle).

The adjustment of the trimmer condensers A (C 106) - B (C 107) - C (C 113) should not be varied, since otherwise the conditions as to the oscillator radiation, stability and alignment are no longer guaranteed.

Schéma avec indications des tensions et des courants

Le réglage des trimmer de neutralisation A (C 106), du trimmer du circuit HF de l'onde B (C 107) et du trimmer de l'oscillateur C (C 113) ne doit pas être modifié, si non le limite prescrite du rayonnement perturbateur, la stabilité ainsi que la précision d'atunage de récepteur ne sont plus garanties.

No ha de variarse el ajuste de los condensadores-trimmer A (C 106) B (C 107) - C (C 113), ya que sino se andeamos garantizar la supresión de radiaciones parásitas y la estabilidad así como el objeto de este ajuste del aparato.

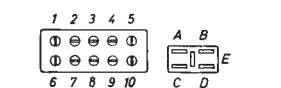
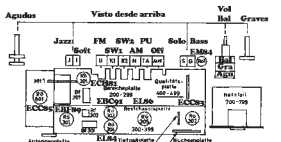
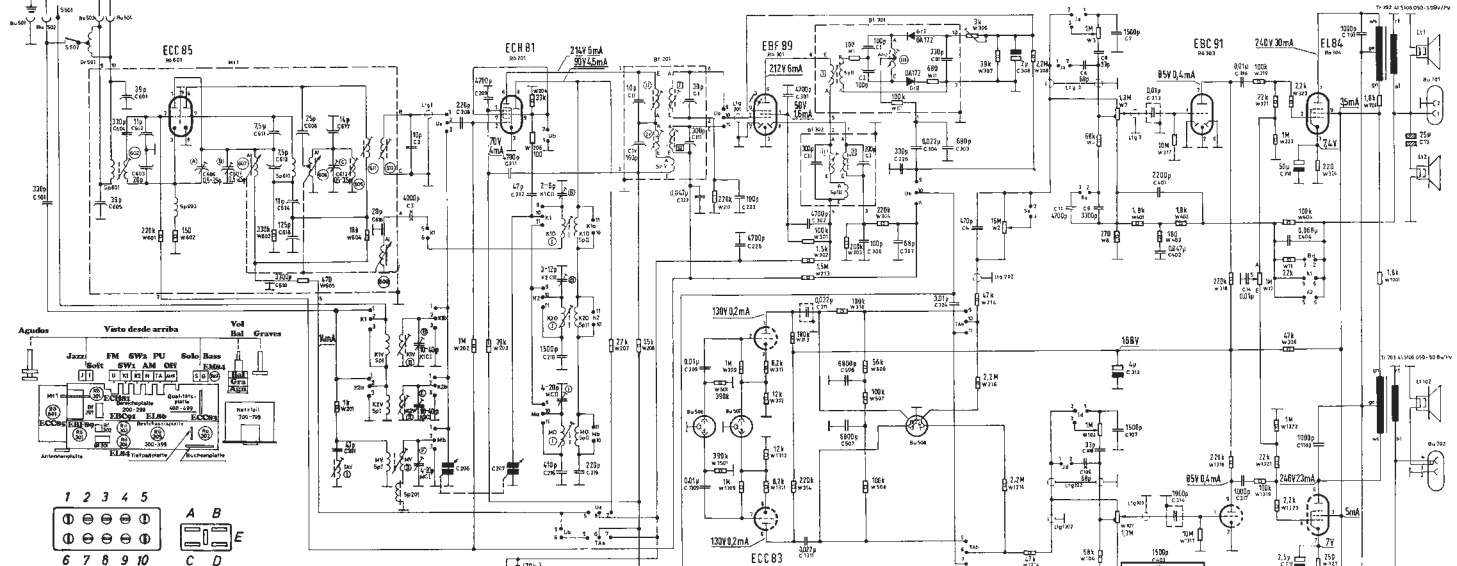

Anschlußplatten des UKW Eingangs- und Mischfeldkreises
Terminal plates of the VHF input and mixer unit
Cassas de recordación do bloc HF Oscillateur FM
Placas de conexión de la caja que contiene las etapas de entrada y mezcla de onda ultracorta

Au PLATO Telefunken TW504c
Au Cápsula Telefunken T200

Frontal, interior SW

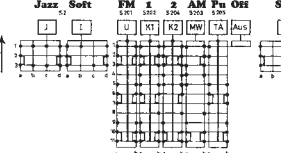

Der Testnetz ist in Reihenschaltung geschaltet. Beim Drücken der einzelnen Berührungskontakte bewegt sich der desgehörige Kontaktstrahler in Pfeilrichtung.
The contact bridges are shown in unoperated position. When pressing a button, the corresponding slider with its contact bridges will move in the direction of the arrow.
Le commutateur a récepteur est illustré sur position « non enclenché ». En appuyant les touches de chaque commande d'ondes, les curseurs à contacts se déplacent dans le sens de la flèche. La illustration démontre également le fonctionnement de la commande correspondante en direction de la flèche.

Solo, Bass



Alle Spannungs- und Stromwerte sind mit einem Instrument 50 k Ω /V gemessen.
All voltages have been taken with the push button 'UKW' pressed.
Unterstrichenen Werte von AW umgeschaltet.
Underlined values have been taken in position 'AW'.

W 7W 107 = Lautstärkeregler
Volume control
Régulateur de volume
Control de volumen

W 3W 103 = Höhenregler
Trebble control
Régage de aigus
Control de agudos

W 2 = Tiefenregler
Bass control
Régage des graves
Control de bajos

W 12 = Balanceregler
Balancing control
Régage de balance
Control de balance

Bu 506 = Plattenspieler
Record player
Toune-disques
Tocadiscos

Bu 507 = Balanceregler (Zubehör)
Balancing control (Accessories)
Régage de balance (Accessories)
Control de balance (Accessories)

Bu 508 = Tonhöhenregler
Tone exciter
Magnétophone
Grabbeides de cinto

Bu 701 = Außenlautsprecher
Haut-parleur extérieur
Altoparlante exterior

Bu 702 = Stereo-Außenlautsprecher
Stereo external speaker
Haut-parleur stéréo extérieur
Altoparlante exterior estereofónica

2205 OA

Die Funktionen Indikator und Volume sind reserviert für ein Voltmeter von 50 k Ω /V.
Toutes les valeurs des tensions et des courants sont mesurées avec commutateur de guignes d'ondes sur position UKW (FM).
Los valores indicados son medidos con un voltímetro de 50 k Ω /V.
Todos los valores de medición han sido tomados en la posición «Linha Ultracorta» (UKW) de los conmutadores.
Los valores subrayados son válidos en posición AW.

Vista Frontal

OFF PU TAPE AM SW2 SW1 FM

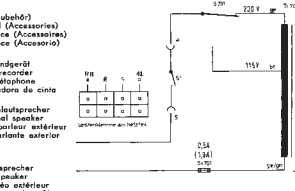

Tous les tensions sont mesurées avec un voltímetro de 50 k Ω /V.
Todos los valores de medición han sido tomados en la posición «Linha Ultracorta» (UKW) de los conmutadores.
Los valores subrayados son válidos en posición AW.

Soft Jazz

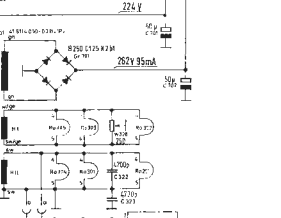

Alle Spannungs- und Stromwerte sind mit einem Instrument 50 k Ω /V gemessen.
All voltages have been taken with the push button 'UKW' pressed.
Unterstrichenen Werte von AW umgeschaltet.
Underlined values have been taken in position 'AW'.

Änderung der Schaltung vorbehalten
Alteration of this diagram reserved
Changement de schéma réservé
Siervo la alteración del esquema

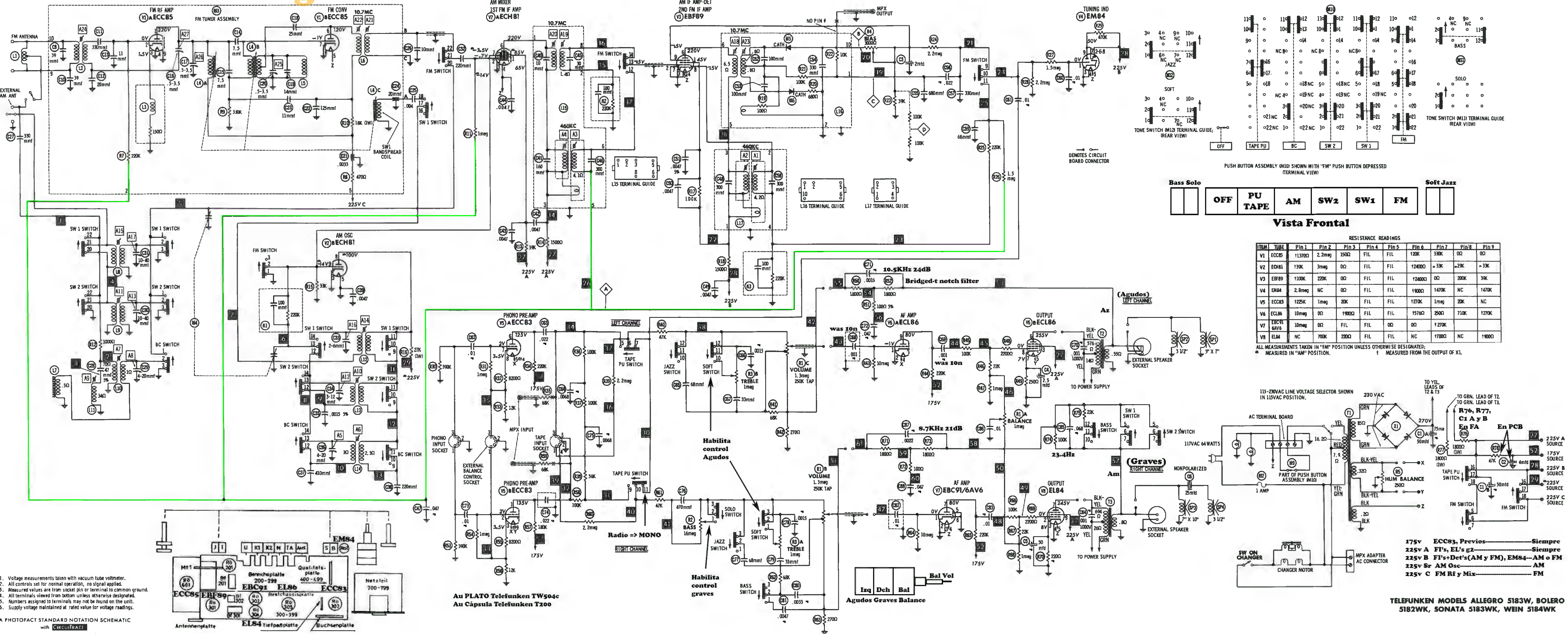

RESISTANCE READINGS

ITEM	TUBE	Pin 1	Pin 2	Pin 3	Pin 4	Pin 5	Pin 6	Pin 7	Pin 8	Pin 9
V1	ECC85	11370Ω	2.2meg	150Ω	FIL	FIL	120K	330K	0Ω	0Ω
V2	ECH81	139K	3meg	0Ω	FIL	FIL	12400Ω	~33K	~29K	~33K
V3	EBF89	1100K	220K	0Ω	FIL	FIL	12400Ω	0Ω	200K	39K
V4	EM84	2.8meg	NC	0Ω	FIL	FIL	1900Ω	1470K	NC	1470K
V5	ECC83	1225K	1meg	20K	FIL	FIL	1270K	1meg	20K	NC
V6	ECL86	10meg	0Ω	1900Ω	FIL	FIL	1576Ω	250Ω	710K	1270K
V7	EBC91/6AV6	10meg	0Ω	FIL	FIL	0Ω	0Ω	1270K		
V8	EL84	NC	700K	220Ω	FIL	FIL	NC	1700Ω	NC	1900Ω

ALL MEASUREMENTS TAKEN IN "FM" POSITION UNLESS OTHERWISE DESIGNATED;
 • MEASURED IN "AM" POSITION. † MEASURED FROM THE OUTPUT OF X1.

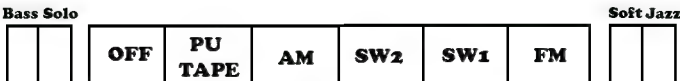

Vista Frontal

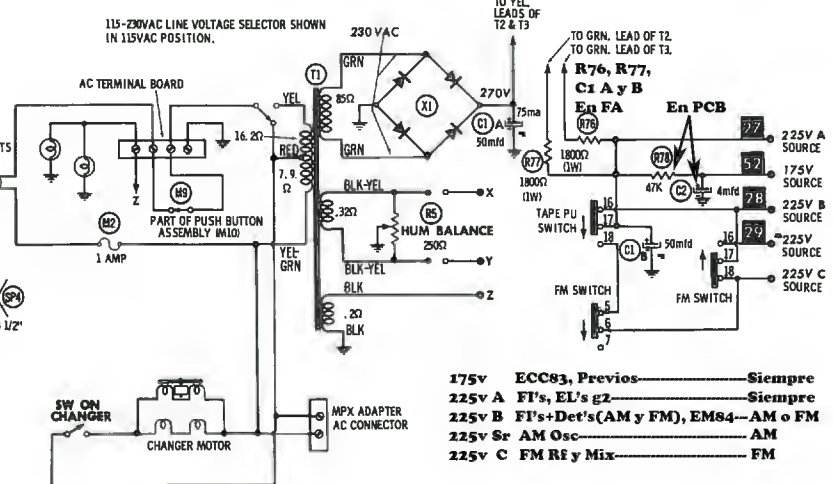

- 175v ECC83, Previos ————— Siempre
- 225v A FI's+Det's(AM y FM), EM84 ————— Siempre
- 225v B FI's+Det's(AM y FM), EM84 ————— AM o FM
- 225v Sr AM Osc ————— AM
- 225v C FM Rf y Mix ————— FM

TELEFUNKEN MODELS ALLEGRO 5183W, BOLERO 5182WK, SONATA 5183WK, WEIN 5184WK

1. Voltage measurements taken with vacuum tube voltmeter.
2. All controls set for normal operation, no signal applied.
3. Measured values are from socket pin or terminal to common ground.
4. All terminals viewed from bottom unless otherwise designated.
5. Numbers assigned to terminals may not be found on the unit.
6. Supply voltage maintained at rated value for voltage readings.

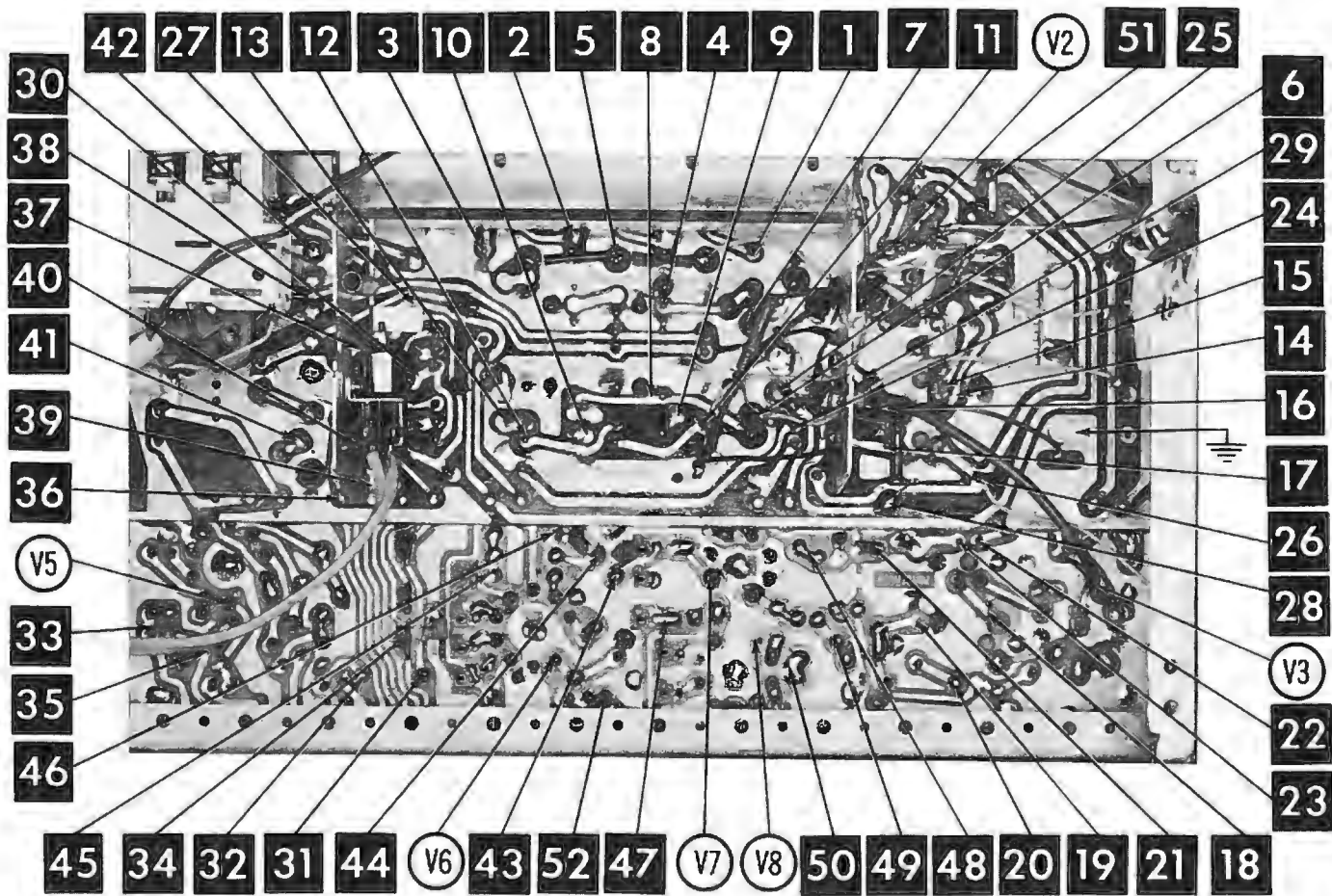

A Howard W. Sams **CIRCUITRACE** Photo

RADIO PRINTRD BOARD

ARROWS INDICATING TUBE LOCATIONS ARE POINTING TO PIN 1 UNLESS OTHERWISE INDICATED

TELEFUNKEN MODELS ALLEGRO 5183W,
 BOLERO 5182WK, SONATA 5183WK, WEIN 5184WK

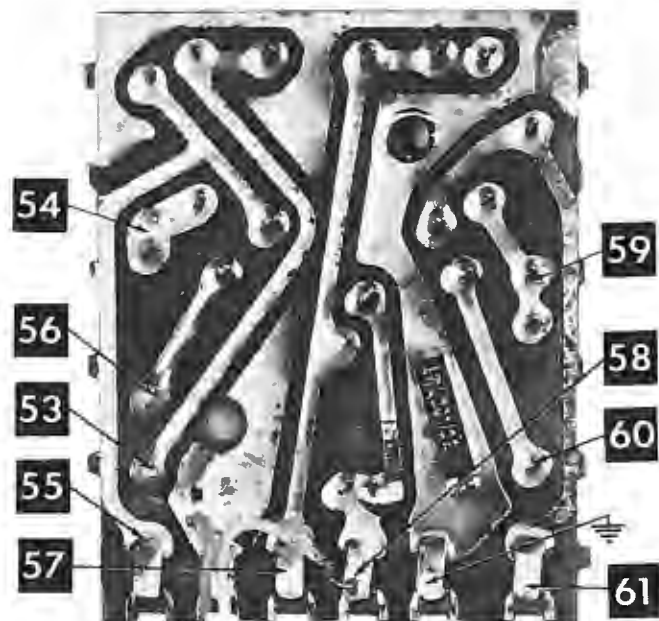

A Howard W. Sams **CIRCUITRACE** Photo

**FEED-BACK
 PRINTED BOARD**

ARROWS INDICATING TUBE LOCATIONS ARE POINTING TO PIN 1 UNLESS OTHERWISE INDICATED

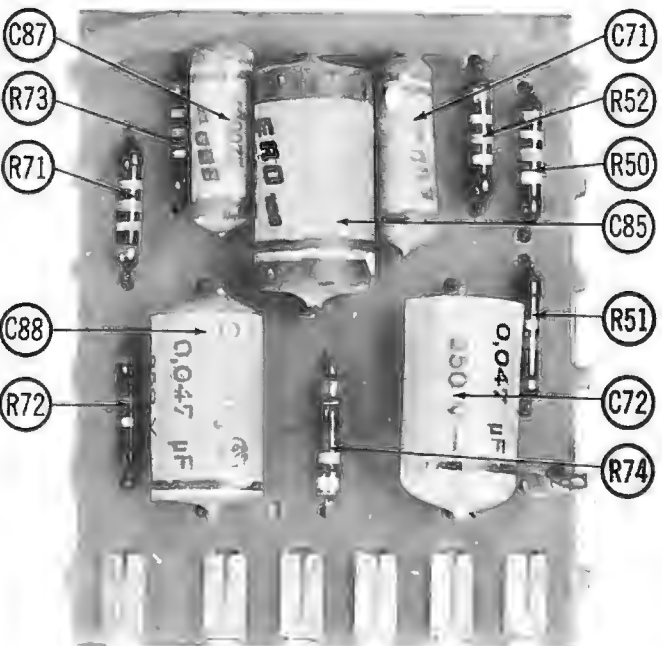

FOLDER 12

TUBES

Table with columns: ITEM No., USE, TYPE, AMPEREX, GENERAL ELECTRIC, RCA, RAYTHEON, SYLVANIA.

POWER RECTIFIERS

Table with columns: ITEM No., MEASURED CURRENT, ORIGINAL Part or Type No., RECTIFIERS (MALLORY, RCA, SARKES TARZIAN).

When replacing selenium rectifier with silicon type, add series resistance to obtain original output voltage.

ELECTROLYTIC CAPACITORS

Table with columns: ITEM No., RATING (CAP., VOLT.), REPLACEMENT DATA (Telefunken, AEROVOX, CORNELL-DUBILIER, GENERAL ELECTRIC, GENERAL INSTRUMENT, MALLORY, SPRAGUE).

* Not normally in distributor's stock. Available thru distributor on order to manufacturer.

FIXED CAPACITORS

Table with columns: ITEM No., RATING, REMARKS, REPLACEMENT DATA (AEROVOX, CENTRALAB, CORNELL-DUBILIER, ELMENCOR, MALLORY, SPRAGUE).

FIXED CAPACITORS (cont)

Table with columns: ITEM No., RATING, REMARKS, REPLACEMENT DATA (AEROVOX, CENTRALAB, CORNELL-DUBILIER, ELMENCOR, MALLORY, SPRAGUE).

CONTROLS

All wattages 1/2 watt, or less, unless otherwise listed.

Table with columns: ITEM No., USE, RESISTANCE, REPLACEMENT DATA (Telefunken, CENTRALAB, CLAROSTAT, CTS-IRC, MALLORY).

COILS (RF-IF)

Table with columns: ITEM No., USE, REPLACEMENT DATA (Telefunken, MERIT, MILLER, STANCOR, WORKMAN), NOTES.

TRANSFORMER (POWER)

Table with columns: ITEM No., RATING, REPLACEMENT DATA (Telefunken, MERIT, STANCOR, THORDARSON, TRIAD), NOTES.

TRANSFORMER (AUDIO OUTPUT)

Table with columns: ITEM No., IMPEDANCE, REPLACEMENT DATA (Telefunken, MERIT, STANCOR, THORDARSON, TRIAD), NOTES.

SPEAKER

Table with columns: ITEM No., TYPE, REPLACEMENT DATA (Telefunken, QUAM), NOTES.

COMPONENT COMBINATIONS

Table with columns: ITEM No., USE, DESCRIPTION, Telefunken PART No., REPLACEMENT DATA.

PHONO CARTRIDGE & NEEDLES

*NEEDLE LISTINGS SHOWN ARE FOR RESPECTIVE REPLACEMENT CARTRIDGES ONLY.

Table with columns: ITEM No., REPLACEMENT DATA (Telefunken, ASTATIC, ELECTRO-VOICE, SONOTONE), NOTES.

FUSES

Table with columns: ITEM No., TYPE, RATING, REPLACEMENT DATA (Telefunken, LITTELFUSE, BUSS), HOLDER.

MISCELLANEOUS

Table with columns: ITEM No., PART NAME, Telefunken PART No., NOTES.

CABINETS & CABINET PARTS

(When Ordering Specify Model, Chassis & Color)

Table with columns: ITEM, PART No., ITEM, PART No.

WIRING DATA

Table with columns: General-use Unshielded Hook-up Wire, Power Cord, Power Cord (Interlock Type), Low-Loss Shielded Lead, Phono Pick-up Arm Cable.

TELEFUNKEN MODELS ALLEGRO 5183W, BOLERO 5182WK, SONATA 5183WK, WEIN 5184WK

FOLDER 12

ALIGNMENT INSTRUCTIONS

Maintain line voltage at rated value. Allow a 15 minute warmup for receiver and equipment.

Use only enough generator output to obtain a suitable indication.

Suggested Alignment Tools: A1 thru A27 GENERAL CEMENT #8290, 8868, 9087 WALSCO #2525, 2528, 2587

AM ALIGNMENT - SELECTOR IN AM POSITION

	SIGNAL GENERATOR COUPLING	SIGNAL GENERATOR FREQUENCY	RADIO DIAL SETTING	OUTPUT METER	ADJUST	REMARKS
1.	Fashion loop of several turns of wire and radiate signal into loop of receiver.	460KC	(BC) Tuning gang fully open.	DC probe of VTVM to point \diamond , common to ground.	A1, A2, A3, A4	Adjust for maximum.
2.	"	1620KC	1620KC	"	A5	"
3.	"	600KC	600KC	"	A6, A7	"
4.	"	1400KC	1400KC	"	A8	"
5.	"	480KC	Tuning gang fully open.	"	A9	Adjust for MINIMUM
6.	"	2.9MC	(S. W. 2) 2.9MC	"	A10, A11	Adjust for maximum
7.	"	6MC	6MC	"	A12, A13	"
8.	"	7MC	(S. W. 1) 7MC	"	A14, A15	"
9.	"	22MC	22MC	"	A16, A17	"

FM ALIGNMENT USING AM SIGNAL GENERATOR - SELECTOR IN FM POSITION

Connect two matched 100K ($\pm 1\%$) resistors in series from point \diamond to chassis. The junction of these two resistors is alignment point \diamond as shown on the schematic.

High side to ungrounded shield over FM converter tube, low side to ground; OR across FM antenna terminals with 120 Ω carbon resistor in series with each lead.

	GENERATOR FREQUENCY	DIAL SETTING	INDICATOR	ADJUST	REMARKS
10.	10.7MC (Unmod.)	Point of non-interference.	DC probe of VTVM to point \diamond ; common to ground.	A18 thru A22	Adjust for maximum.
11.	"	"	DC probe to point \diamond ; common to point \diamond .	A23	Adjust for zero reading. A positive or negative reading will be obtained on either side of the correct setting.
12.	90MC (Unmod.)	90MC	DC probe of VTVM to point \diamond ; common to ground.	A24	Adjust for maximum.
13.	108MC	108MC	"	A25, A26, A27	"

FM IF ALIGNMENT USING FM SIGNAL GENERATOR - SELECTOR IN FM POSITION

High side to ungrounded shield over FM converter, low side to ground.

Use 80v frequency modulated signal with 45KC sweep. Use 120v sawtooth voltage in scope for horizontal deflection.

	GENERATOR FREQUENCY	DIAL SETTING	INDICATOR	ADJUST	REMARKS
10.	10.7MC (450KC Swp.)	Point of non-interference.	Vert. amp. of scope to point \diamond ; low side to ground.	A18, A19, A20, A21, A22	Adjust for maximum gain and symmetry of response similar to Fig. 1 with marker as shown.
11.	"	"	Vert. amp. to point \diamond ; low side to ground.	A23	Adjust to place marker at center of crossover lines similar to Fig. 2. SLIGHTLY retouch A18 for maximum amplitude and straightness of crossover lines.

FM STEREO MULTIPLEX ALIGNMENT USING FM STEREO SIGNAL GENERATOR ($\pm .000\%$) ACCURACY

High side to MPX input, low side to ground.

Suggested Alignment Tools: A28 thru A32 GENERAL CEMENT #8282, 8806, 9302 WALSCO #2543, 2544, 2588

	GENERATOR FREQUENCY	DIAL SETTING	INDICATOR	ADJUST	REMARKS
14.	"	Vert. Amp. thru 47K to point \diamond , low side to ground.		A28	Adjust for maximum. Set scope to lock in 2 cycles of 19KC waveform.
15.	"	Vert. Amp. to point \diamond , low side to ground		A29	Adjust for maximum 4-cycle waveform.
16.	67KC	Vert. Amp. thru 47K to point \diamond , low side to ground.		A30, A31	Use Audio Oscillator if necessary. Adjust for MINIMUM
17.	"	Vert. Amp. thru 47K to point \diamond , low side to ground.		A32	Adjust for maximum.
18.	Modulated Left channel	Vert. Amp. to point \diamond , low side to ground.		R6	Adjust for MINIMUM output at point
19.	Modulated Right channel	Vert. Amp. to point \diamond , low side to ground.		R6	Check for MINIMUM output at point \diamond . Make compromise adjustment if necessary.

To align multiplex section using an air signal, first make sure FM section is properly aligned. Tune in a strong FM stereo signal. Follow steps 14-16 above except in step 16 adjust to eliminate whistle or interference.

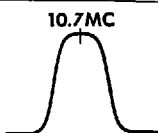

FIG. 1

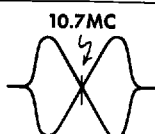
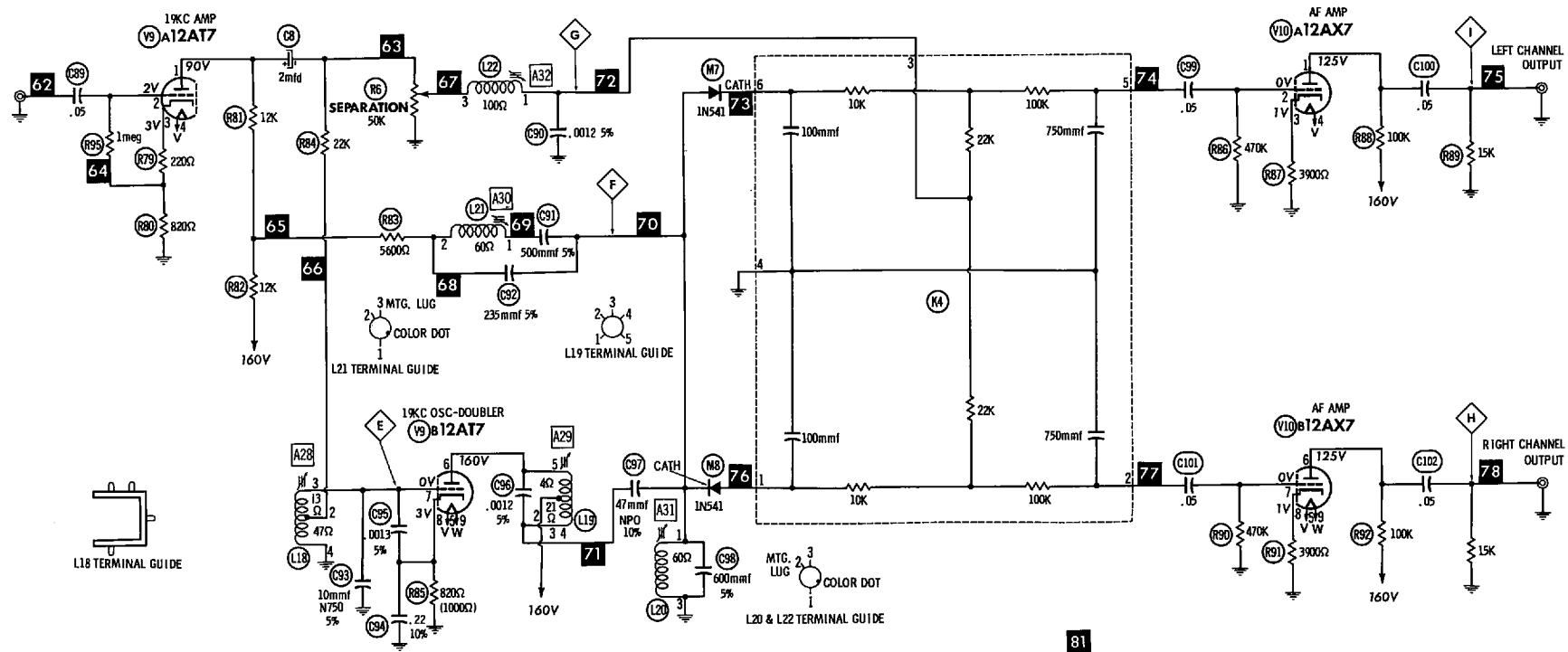

FIG. 2



RESISTANCE READINGS

ITEM	TUBE	Pin 1	Pin 2	Pin 3	Pin 4	Pin 5	Pin 6	Pin 7	Pin 8	Pin 9
V9	12A7	127K	1meg	1000Ω	FIL	FIL	12700Ω	60Ω	820Ω	FIL
V10	12AX7	1100K	470K	3900Ω	FIL	FIL	1100K	470K	3900Ω	FIL

† MEASURED FROM OUTPUT OF X2.

1. Voltage measurements taken with vacuum tube voltmeter.
2. All controls set for normal operation, no signal applied.
3. Measured values are from socket pin or terminal to common ground.
4. All terminals viewed from bottom unless otherwise designated.
5. Numbers assigned to terminals may not be found on the unit.
6. Supply voltage maintained at rated value for voltage readings.

A PHOTOFAC STANDARD NOTATION SCHEMATIC
with CIRCUITRACE

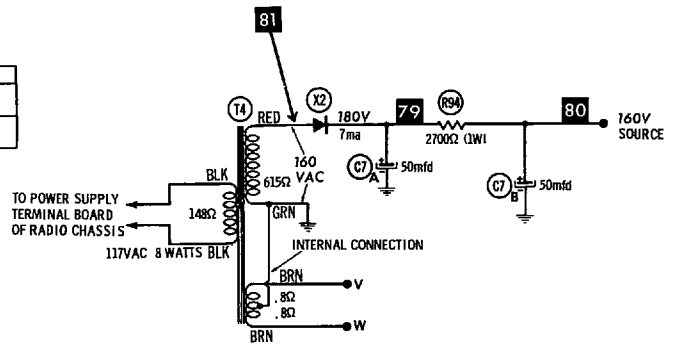

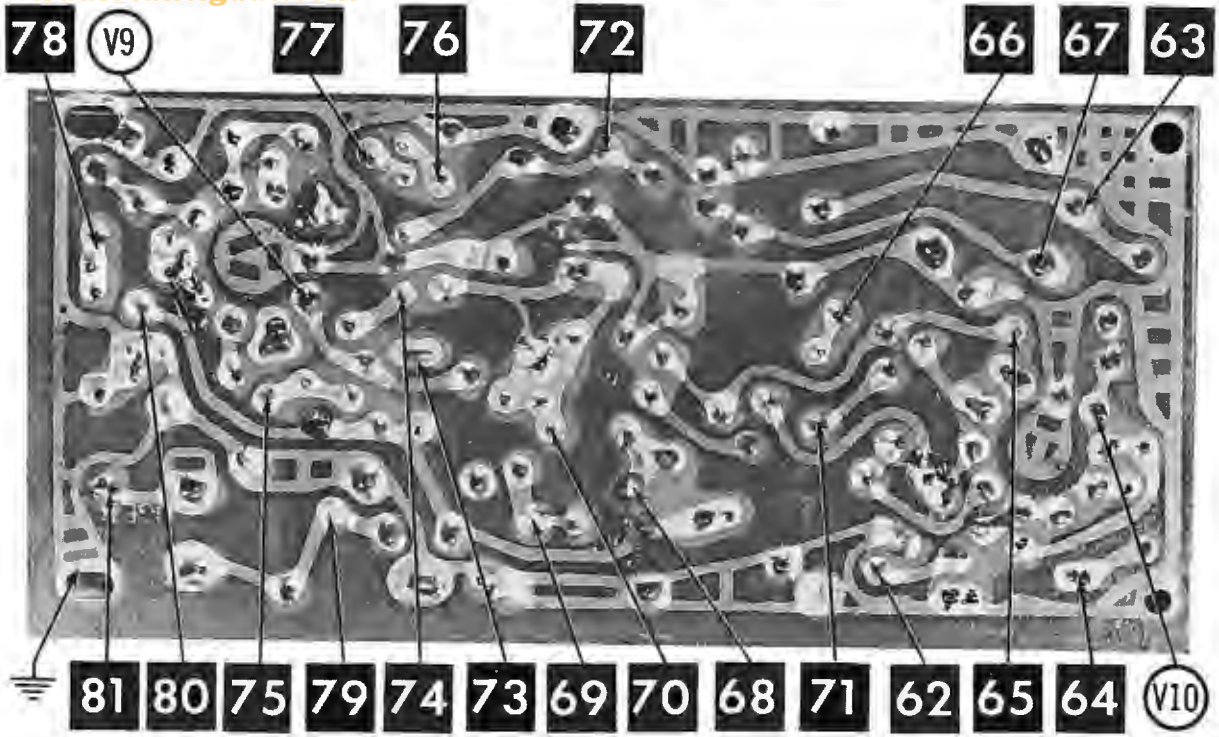

A Howard W. Sams CIRCUITRACE® Photo

MPX PRINTED BOARD

ARROWS INDICATING TUBE LOCATIONS ARE POINTING TO PIN 1 UNLESS OTHERWISE INDICATED

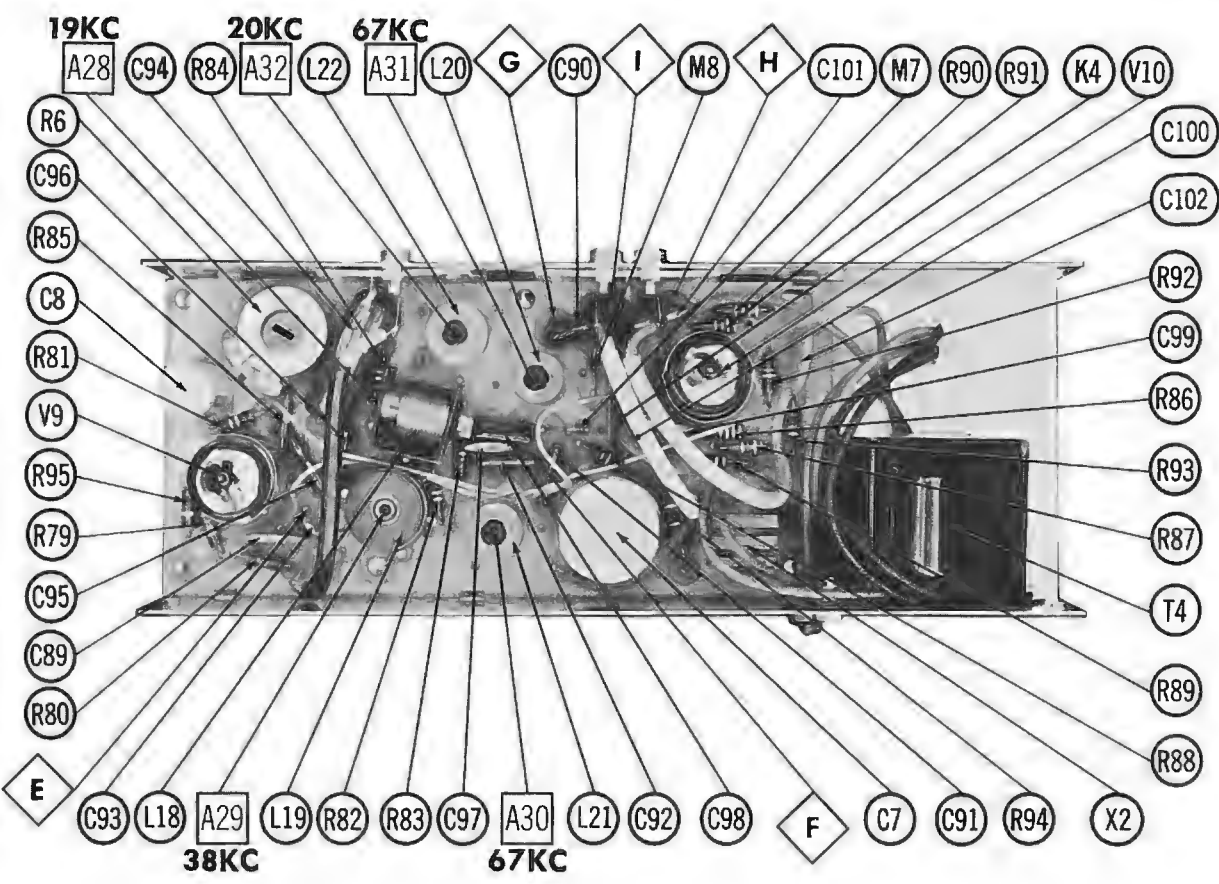

MPX CHASSIS TOP VIEW

TELEFUNKEN MODELS ALLEGRO 5183W,
BOLERO 5182WK, SONATA 5183WK, WEIN 5184WK

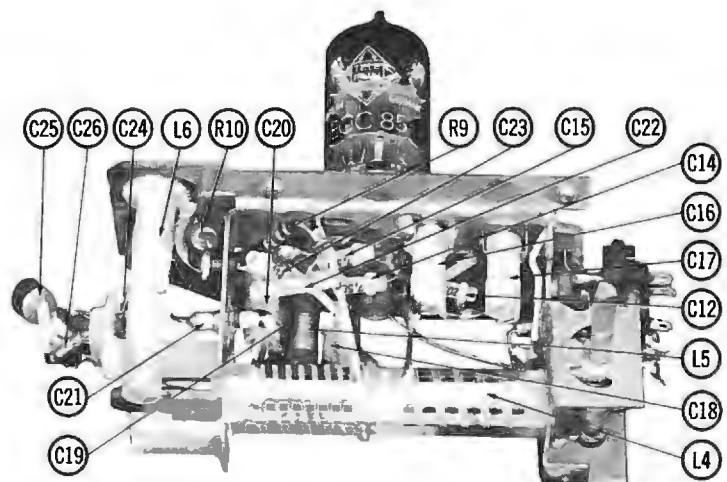
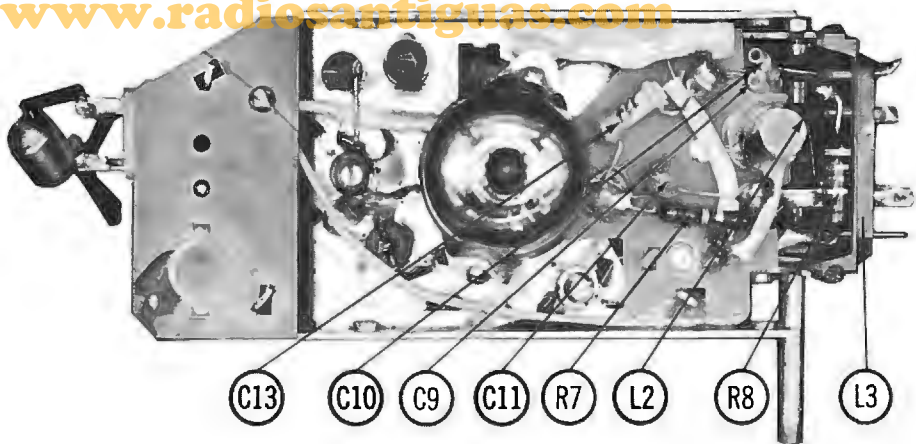

FM RF SUBCHASSIS

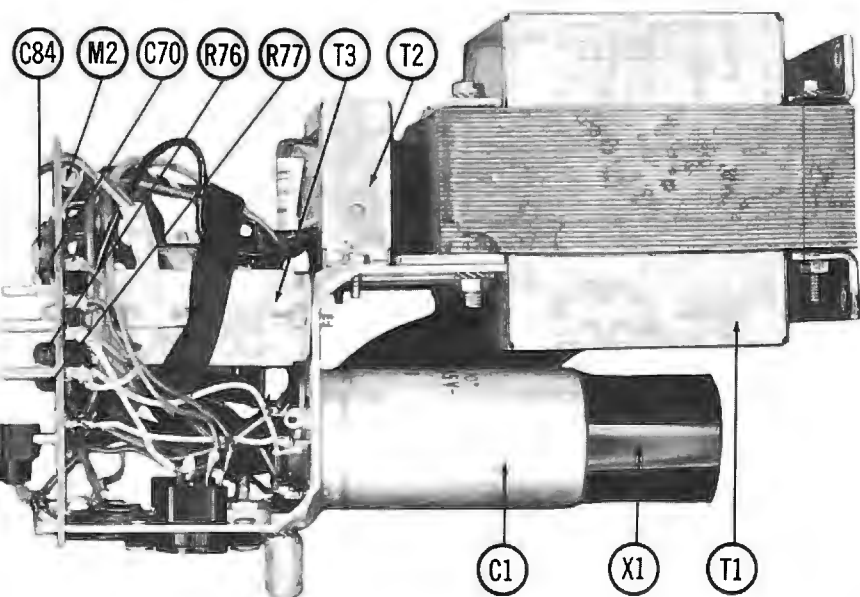

AMP & POWER SUPPLY SUBCHASSIS

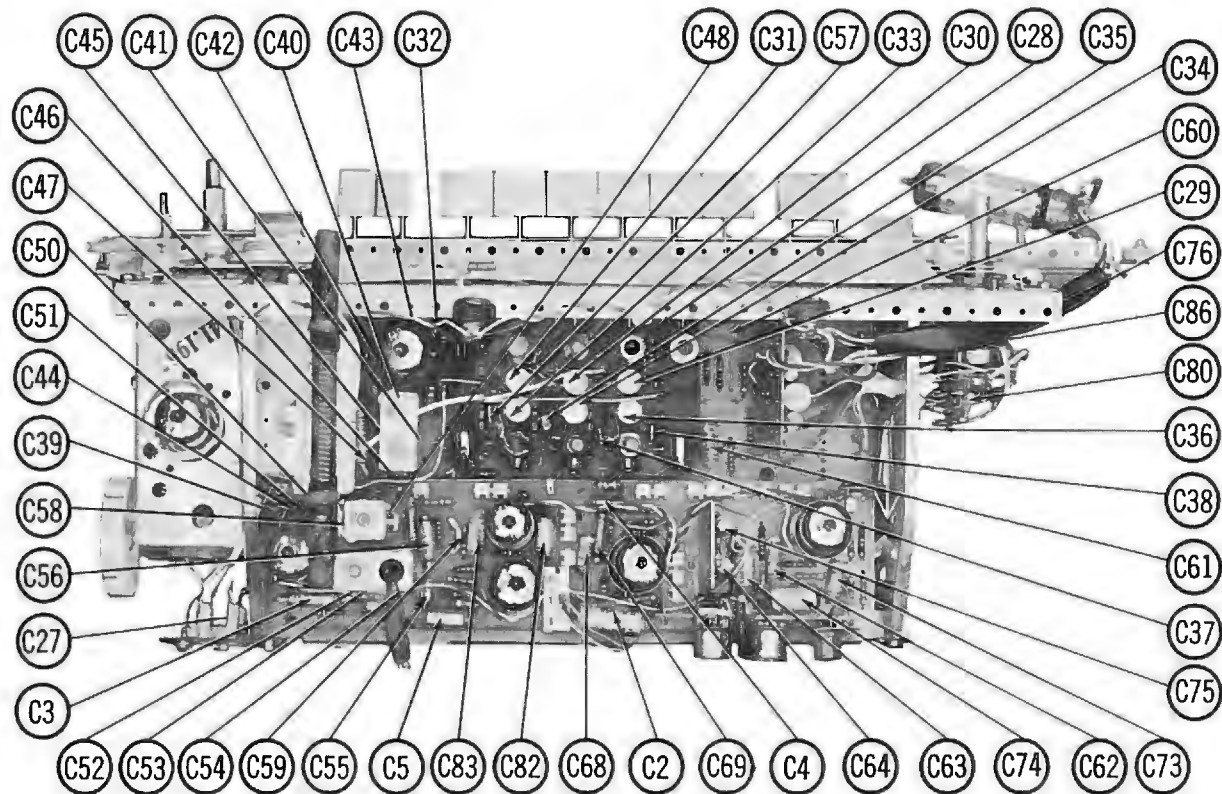

CHASSIS BOTTOM VIEW—CAPACITOR IDENT.

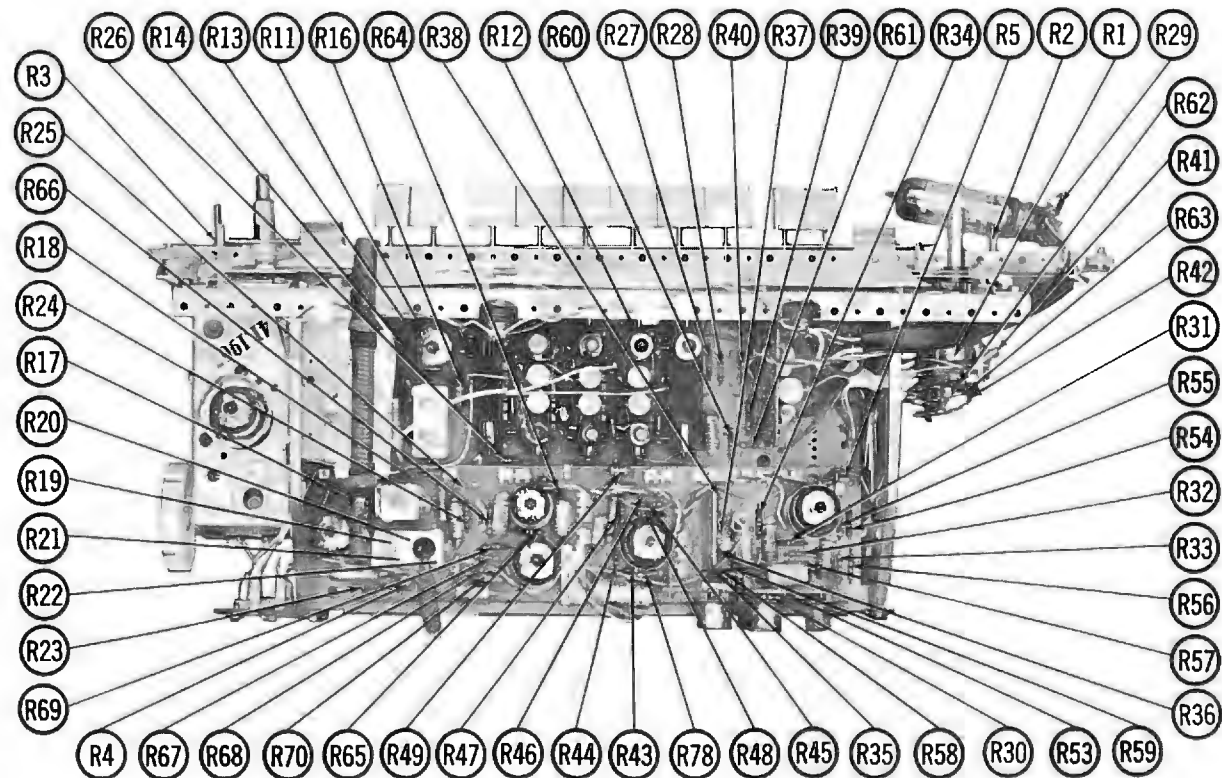

CHASSIS BOTTOM VIEW—RESISTOR IDENT.